



passionate by  
**nature**

general catalogue



PASSIONATE BY NATURE



# benvenuti

tra le pagine del nostro catalogo

abbiamo pensato a spunti e suggestioni che ruotano attorno ad un mondo a noi tanto caro, quello dei giardini e delle ambientazioni da arredare con prodotti funzionali e decorativi.

Ci trovi anche on line su [www.euro3plast.com](http://www.euro3plast.com)

# bienvenue

dans notre catalogue

nous avons pensé à des idées et des conseils tournant autour d'un monde qui nous est cher, celui des jardins et des ambiances à meubler avec des produits fonctionnels et décoratifs.

Vous pouvez aussi nous trouver en ligne à l'adresse [www.euro3plast.com](http://www.euro3plast.com)

# willkommen

Sie auf den Seiten unseres Katalogs

wir haben uns Ideen und Vorschläge zur Welt der Gärten und Räumlichkeiten, die mit funktionalen und dekorativen Produkten ausgestattet werden sollen, ausgedacht.

Sie finden uns auch online unter [www.euro3plast.com](http://www.euro3plast.com)



bienvenidos

entre las páginas  
de nuestro catálogo

hemos pensado a ideas y sugerencias que giran en torno a un mundo que adoramos, el de los jardines y ambientaciones para embellecer con productos funcionales y decorativos.

Estamos también en línea en las páginas [www.euro3plast.com](http://www.euro3plast.com)

$\frac{2}{3}$

welcome  
to our catalogue

we have thought up some ideas that focus on a world very dear to us: a world of gardens and settings to furnish with functional and decorative products.

Visit us at [www.euro3plast.com](http://www.euro3plast.com)

PASSIONATE BY NATURE



# Get inspired by euro3plast!

<b>company profile</b> .....	6
<b>tecnologie / technologies</b> .....	18
<b>certificazioni / certifications</b> .....	22
<b>servizi / services</b> .....	24
<b>sostenibilità / sustainability</b> .....	28
<b>hobby</b> .....	32
<b>home</b> .....	88
<b>style</b> .....	160
<b>avvertenze / warnings</b> .....	306
<b>indice generale / general index</b> .....	312

PASSIONATE BY NATURE

A passion since 1974



it

Euro3plast nasce nel 1974 producendo prodotti in plastica per il giardino e per la casa. L'innovazione legata alla produzione di vasi, complementi d'arredo e lampade è alla base della continua crescita dell'azienda che oggi distribuisce i suoi prodotti in tutto il mondo.

fr

Euro3plast a été créé en 1974 et fabrique des produits en plastique pour le jardin et la maison. L'innovation caractérisant la production de pots, de compléments d'ameublement et de lampes est à la base de la croissance constante de l'entreprise qui distribue aujourd'hui ses produits dans le monde entier.

de

Euro3Plast entsteht im Jahr 1974 und fertigt Kunststoffartikel für Garten und Haushalt. Die Basis des kontinuierlichen Wachstums des Unternehmens, das seine Erzeugnisse heute weltweit vertreibt, ist die Innovation im Hinblick auf die Herstellung der Blumentöpfe, Einrichtungsobjekte und Leuchten.

es

Euro3plast fue fundada en 1974 para la fabricación de productos de plástico para el jardín y el hogar. La innovación vinculada a la producción de macetas, accesorios de decoración y dispositivos de iluminación es la base del continuo crecimiento de la empresa que hoy distribuye sus productos en todo el mundo.

en

Euro3plast was established in 1974 as a manufacturer of plastic products for home and garden. The innovation linked to the production of pots, furnishing accessories and lighting items, is at the base of the company's continuous growth, which distributes its products all over the world.



it

Immaginiamo soluzioni, abbiniamo colori, plasmiamo forme. Ogni giorno cambiamo senza fermarci mai.

Ascoltiamo la ragione, ma è la passione che guida le nostre scelte per superare la linea delle aspettative.

Ciascun prodotto è unico ed è il riflesso di ciò che siamo: persone che lavorano con entusiasmo unendo organizzazione e intuizione.

fr

Nous imaginons des solutions, nous associons des couleurs, nous modelons des formes. Chaque jour nous changeons, sans jamais nous arrêter.

Nous écoutons la raison, mais c'est la passion qui dicte nos choix pour franchir la ligne des attentes.

Chaque produit est unique et le reflet de ce que nous sommes: des personnes qui travaillent avec enthousiasme, alliant organisation et intuition.

de

Wir erarbeiten Lösungen, stimmen Farben ab und gestalten Formen. Jeden Tag erneuern wir uns ohne Pause.

Wir sind rational und doch werden unsere Entscheidungen durch unsere Leidenschaft geprägt, die unsere Entscheidungen über alle Erwartungen hinaus beeinflusst.

Jedes Produkt ist einzigartig und spiegelt unseren Geist wider: wir arbeiten voller Enthusiasmus und verbinden Organisation mit Eingebung.



# passionate by nature

es

Imaginamos soluciones, combinamos colores, plasmamos formas. Cada día cambiamos sin detenernos nunca.

Escuchamos la razón, pero es la pasión que guía nuestras decisiones para superar la línea de las expectativas.

Cada producto es único y es el reflejo de lo que somos: personas que trabajan con entusiasmo uniendo organización e intuición.

en

We're always thinking up solutions, forms and matching colours. Every day, we're changing, without ever stopping.

We listen to reason, but it is passion that guides our choices to surpass expectations.

Every product is unique and reflects what we are: a team that works enthusiastically, combining organization and intuition.

PASSIONATE BY NATURE

# Our values are written in our DNA



## Quality

**it** - Curiamo ogni minimo dettaglio

**fr** - Nous apportons le plus grand soin aux moindres détails

**de** - Wir achten auf das kleinste Detail

**es** - Cuidamos cada detalle

**en** - We care about every single detail

## Reliability

**it** - Dedichiamo tempo e impegno per assicurare massimi livelli di servizio

**fr** - Nous consacrons beaucoup de temps et d'énergie afin de garantir un niveau de service aussi élevé que possible

**de** - Um ein Höchstmaß an Service gewährleisten zu können, wenden wir Zeit und Engagement auf

**es** - Dedicamos tiempo y compromiso para garantizar óptimos niveles de servicio

**en** - We devote time and commitment to ensuring the highest level of service

## Innovation

**it** - La tecnologia come mezzo per esprimere al meglio la creatività

**fr** - La technologie pour exprimer au mieux la créativité

**de** - Die Technologie, die die Kreativität am besten zum Ausdruck bringt

**es** - La tecnología para expresar la creatividad de la mejor manera

**en** - Technology as a mean of expressing creativity in the best possible way

# 1974

**it** - iniziamo a produrre i primi articoli per la casa

**fr** - lancement de la production de nos premiers articles pour la maison

**de** - wir produzieren unsere ersten Haushaltsartikel

**es** - empezamos a producir los primeros artículos para el hogar

**en** - we begin to manufacture the first items for the home



# 1983

**it** - incrementiamo la produzione nel settore garden

**fr** - augmentation de la production dans le secteur garden

**de** - wir steigern die Produktion von Gartenartikeln

**es** - aumento de la producción en el sector jardín

**en** - we increase the production in the garden field



# 1992

**it** - introduzione della produzione rotazionale

**fr** - introduction du rotomoulé

**de** - wir fangen mit dem Rotationsformen an

**es** - introducción del rotomoldeo

**en** - introduction of rotational moulding



# 2004

**it** - trasferimento nel nuovo sito produttivo

**fr** - transfert à la nouvelle usine

**de** - wir ziehen in das neue  
Fabrikgebäude um

**es** - traslado a la nueva nave

**en** - moving to the new headquarters



# 2014

**it** - i nostri primi 40 anni

**fr** - 40 ans de activité

**de** - unsere ersten 40 Jahren

**es** - los primeros 40 años

**en** - our first 40 years



**it** - l'obiettivo è scegliere  
di essere originali, sempre!

**fr** - le but est choisir d'être  
toujours original!

**de** - das Ziel ist immer  
originell zu sein!

**es** - el objetivo es elegir  
de ser original, siempre!

**en** - the goal is to choose  
to be original, always!



97%

**it** - livello di servizio garantito al cliente  
**fr** - niveau de service garanti au client  
**de** - garantiertes Kundenservice-Niveau  
**es** - nivel de servicio garantizado al cliente  
**en** - guaranteed customer service level

5%

**it** - percentuale investita nello sviluppo e ricerca di nuovi prodotti  
**fr** - pourcentage investi dans le développement et la communication de nouveaux produits  
**de** - investitionen in die Entwicklung und die Kommunikation für neue Erzeugnisse  
**es** - porcentaje invertido en el desarrollo y la comunicación de nuevos productos  
**en** - percentage invested in developing and communicating new products

2.400.000 kg

**it** - materia prima lavorata all'anno  
**fr** - matière première travaillée par an  
**de** - jährlich verarbeitete Rohstoffe  
**es** - materia prima procesada por año  
**en** - raw materials processed per year

120

**it** - tipologie di colori e finiture  
**fr** - types de couleurs et de finitions  
**de** - farben und oberflaechen-ausfuehrungen  
**es** - distintos tipos de colores y acabados  
**en** - types of colours and finishing

warehouse

warehouse

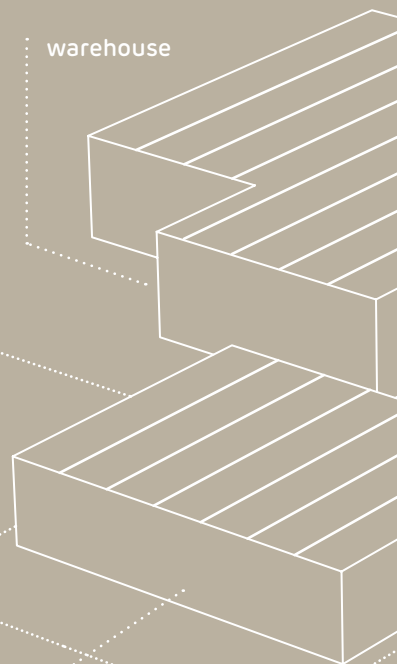

# 32.000 mq

**it** - superficie produttiva dell'azienda  
**fr** - surface de production de l'entreprise  
**de** - produktionsfläche  
**es** - superficie de la empresa dedicada a la producción  
**en** - manufacturing surface of the company

company profile  
key facts



# 60

**it** - mercati differenti  
**fr** - marchés différents  
**de** - verschiedene Märkte  
**es** - mercados diferentes  
**en** - different markets

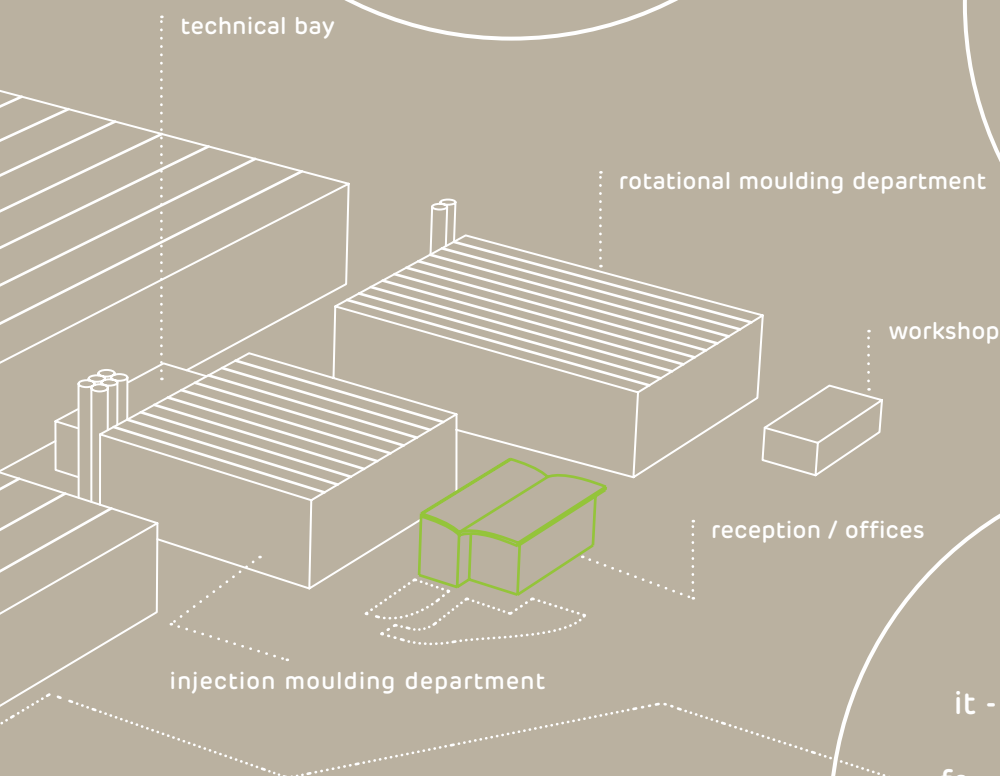

14  
15

# 3

**it** - sistemi di gestione: qualità, ambiente e sicurezza  
**fr** - systèmes de gestion: qualité, environnement et sécurité  
**de** - managementsysteme: Qualität, Umwelt und Sicherheit  
**es** - sistemas de gestión: calidad, medio ambiente y seguridad  
**en** - management systems: quality, environment and safety

# 5.400.000

**it** - pezzi prodotti all'anno  
**fr** - pièces produites par an  
**de** - gefertigte Teile pro Jahr  
**es** - piezas fabricadas por año  
**en** - items produced per year



# Our values



## Quality

Cura e attenzione del dettaglio in ogni ambito.

Soin et attention au moindre détail, dans tous les domaines.

Sorgfältige Detailpflege in jedem Bereich.

Cuidado y atención del detalle en cada sector.

Care and attention to detail in every sphere.



## Customer

"La nostra più grande risorsa è il cliente! Tratta ogni cliente come se fosse l'unico."

"Notre plus grande ressource, c'est le client ! Traitez chaque client comme si c'était le seul."

"Unser größtes Kapital ist der Kunde! Behandle jeden kunden so, als ob er der einzige wäre."

"¡El cliente es nuestro mayor recurso! Trata cada cliente como si fuera el único."

"Our greatest asset are our customers! Treat every one of them as if they were the only one."  
(Laurice Leitao)



## Teamwork

Insieme diamo il nostro meglio!

Ensemble nous donnons le meilleur de nous-mêmes!

Gemeinsam geben wir unser Bestes!

Juntos damos lo mejor de nosotros mismos!

Together we express our best!



## Passion

"Scegli il lavoro che ami  
e non lavorerai neppure  
un giorno in tutta la tua vita"

"Choisissez un travail que vous  
aimez et vous n'aurez pas à travailler  
un seul jour de votre vie"

"Wähle einen Beruf, den du liebst,  
und du brauchst keinen Tag  
in deinem Leben mehr zu arbeiten"

"Elige el trabajo que te guste y  
no tendrás que trabajar ni un solo  
día de tu vida"

"Choose a job you love  
and will never have to work  
a day in your life".  
(Confucius)



## Innovation

Passione e curiosità  
guidano l'innovazione:  
un miglioramento continuo che  
distingue il leader dal follower.

Passion et curiosité guident l'innovation:  
une amélioration continue qui distingue le  
leader du suiveur.

Leidenschaft und Neugierde sind der  
Grundstein von Innovationen: die ständige  
Verbesserung unterscheidet den Marktführer  
vom Follower.

La pasión y la curiosidad guían la innovación:  
un mejoramiento continuo que distingue el  
líder del seguidor.

Passion and curiosity drive  
innovation: ongoing improvement  
that sets the leader apart  
from the followers.

# Injection moulding

it

Durante il ciclo di stampaggio a iniezione, il materiale scende dalla tramoggia, viene fuso e poi iniettato nell'impronta dello stampo grazie ad un pistone che scorre nella camera di fusione. Il prodotto viene estratto dopo una fase di raffreddamento che lo solidifica, plasmandolo secondo la forma dello stampo.

fr

Pendant le cycle de moulage, le matériau qui descend de la trémie est fondu, puis injecté dans l'empreinte du moule grâce à un piston qui se déplace dans la chambre de fusion. Le produit est extrait après une phase de refroidissement qui le solidifie et lui donne la forme du moule.

de

Während des Pressvorgangs läuft das Material aus dem Trichter, wird geschmolzen und dann mit Hilfe eines Kolbens, der sich in der Schmelzkammer bewegt, in die Form gespritzt. Im Anschluss an die Abkühlphase, in der das Teil in der Gestalt, die ihm die Form verleiht, erstarrt, wird der Artikel entnommen.

es

Durante el ciclo de moldeado, el material baja de la tolva, se funde y luego se inyecta en la forma del molde gracias a un pistón que se mueve en la cámara de fusión. El producto se extrae después de una fase de enfriamiento que lo solidifica, dándole forma según las líneas del molde.

en

During the moulding cycle, the material descends from the hopper, is made molten and then injected into the mould impression by a piston that slides into the melting chamber. The product is extracted after a cooling phase that solidifies it, shaping it to the mould.

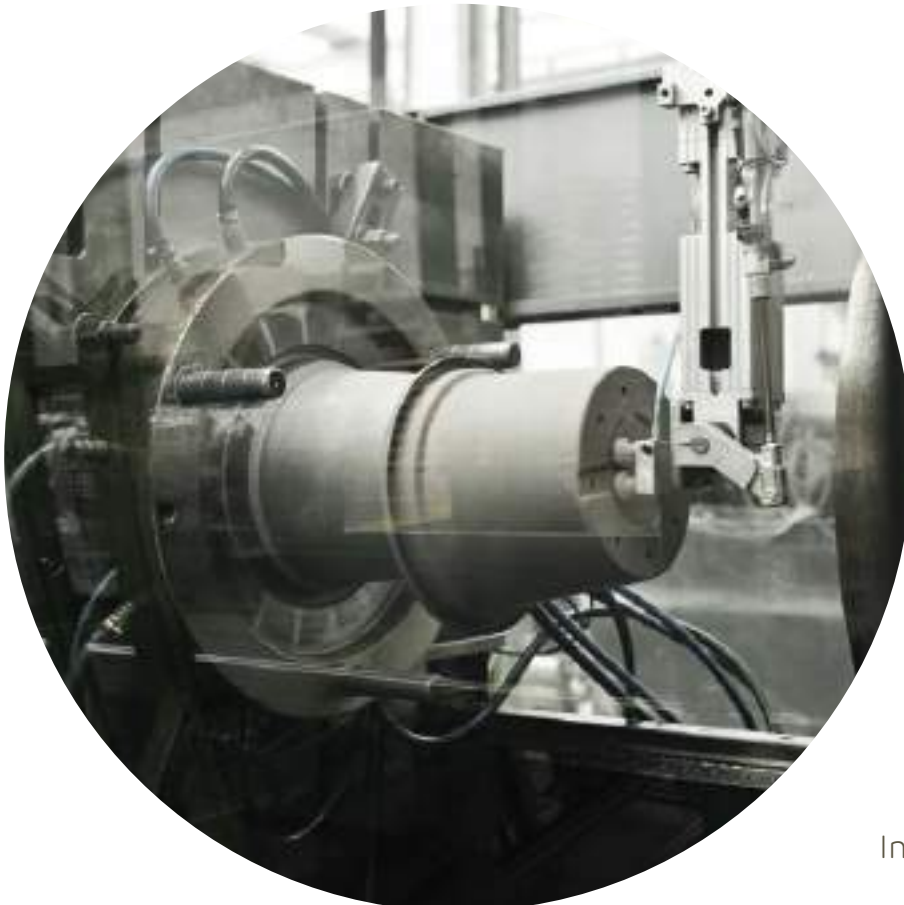



inis  
geo

18  
19



be up



mitu pac

kube



kube high slim light



ikon

# Rotational moulding

it

Le forme sono forgiate da stampi in alluminio dove il materiale in polvere viene inserito, poi riscaldato e fuso all'interno di un forno. Durante la fase di riscaldamento, il ciclo di stampaggio prevede una rotazione lenta, per distribuire il materiale sulle pareti in modo uniforme. Successivamente, il prodotto viene raffreddato, estratto dallo stampo e rifinito manualmente.

fr

Les formes sont créées à partir de moules en aluminium où le matériau en poudre est introduit, puis chauffé et fondu dans un four. Pendant la phase de chauffage, le cycle de moulage effectue une rotation lente pour distribuer uniformément le matériau sur les parois. Le produit est ensuite refroidi, extrait du moule et fini à la main.

de

Die Formen werden aus Aluminium geschmiedet und mit dem pulverförmigen Material gefüllt, das dann in einem Ofen erhitzt und geschmolzen wird. Während der Phase des Erhitzens sieht das Verfahren ein langsames Rotieren vor. Auf diese Weise wird das Material gleichmäßig an den Wänden verteilt. Anschließend wird das Teil abgekühlt, aus der Form entnommen und von Hand fein bearbeitet.

es

Las formas se forjan a partir de moldes de aluminio donde se introduce el material en polvo, se calienta y se funde en un horno. Durante la fase de calentamiento, el ciclo de moldeado implica una rotación lenta para distribuir el material uniformemente sobre las paredes. A continuación, el producto se enfría, se retira del molde y se termina manualmente.

en

The shapes are forged from aluminium moulds where the powder material is inserted, then heated and melted inside an oven. During the heating phase, the moulding cycle involves a slow rotation to distribute the material evenly on the walls. The product is then cooled, removed from the mould and hand-finished.





# We certify our commitment



Abbiamo scelto di seguire normative severe, per garantire non solo la soddisfazione dei clienti, ma anche il rispetto dell'ambiente e la salvaguardia della salute.



Nous avons choisi de suivre des normes sévères, afin de garantir non seulement la satisfaction des clients, mais aussi le respect de l'environnement et la protection de la santé.



Um nicht nur die Zufriedenheit unserer Kunden, sondern auch den Schutz der Umwelt und der Gesundheit zu gewährleisten, haben wir uns dafür entschieden, strenge Bestimmungen einzuhalten.



Hemos optado por la aplicación de normas estrictas para garantizar no solo la satisfacción de los clientes, sino también el respeto del medio ambiente y la protección de la salud.



We have chosen to follow strict regulations to ensure not only customer satisfaction, but also respect for the environment and the protection of health.



Quality management system  
(UNI EN ISO 9001:2015)



Environment management system  
(UNI EN ISO 14001:2015)



Safety management system  
(OHSAS 18001:2007)



# Noi con Voi

per un dialogo sempre aperto

Ci raccontiamo e ascoltiamo  
perché dalla comunicazione reciproca  
nascono sempre le cose migliori.

# Ensemble

pour un dialogue toujours ouvert

Nous nous racontons et nous écoutons  
parce que c'est de la communication réciproque  
que naissent toujours les meilleures choses.

# Us with You

for an always-open dialogue

We open up about ourselves and listen.  
Because the best things come from  
mutual consultation.

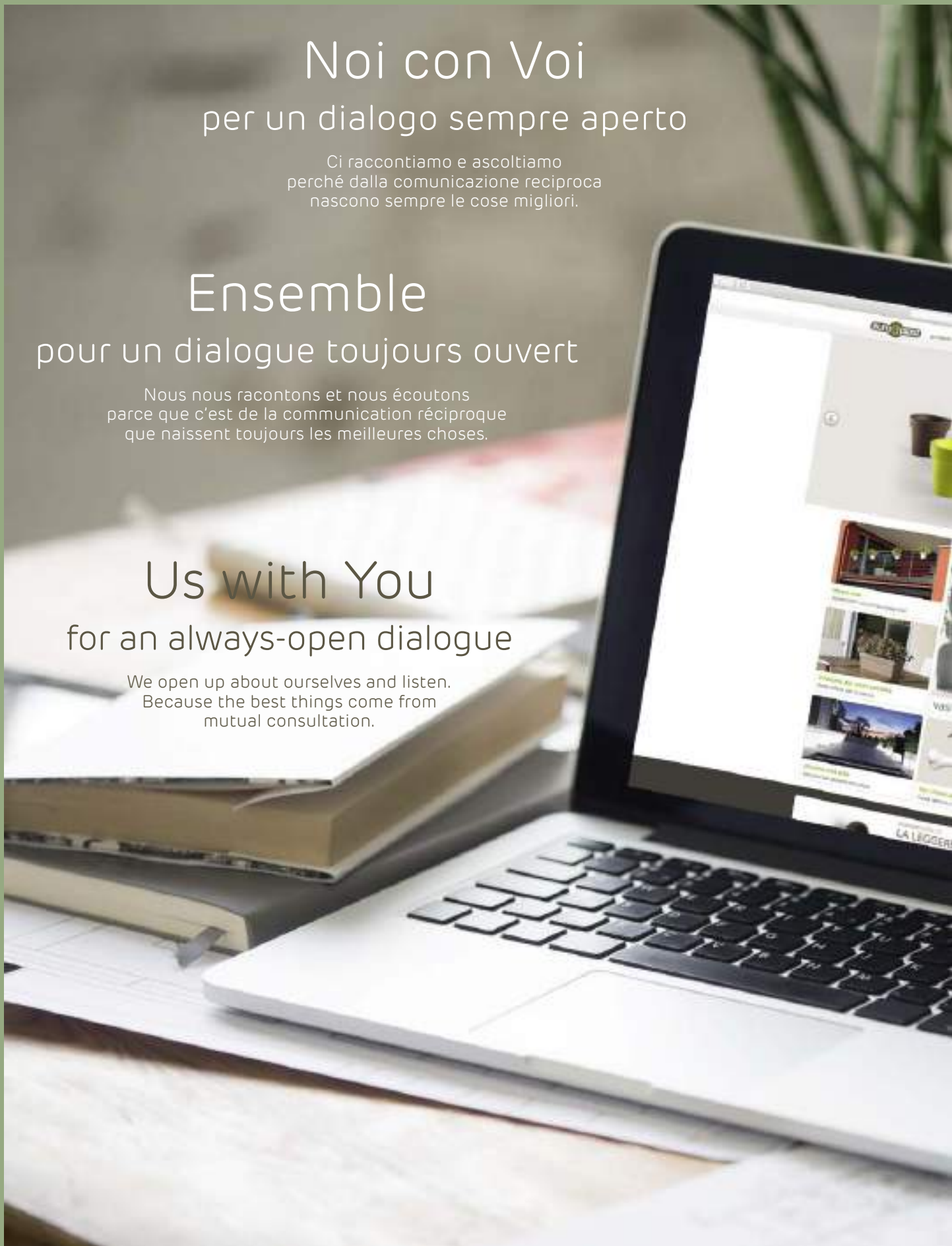

# Wir sind immer für einen offenen Dialog mit Ihnen bereit

Wir erzählen über uns und hören Ihnen zu,  
weil ein offener Dialog immer  
das Beste zu Tage bringt.

# Nosotros con ustedes para un diálogo siempre abierto

Nos describimos y escuchamos porque  
de la comunicación recíproca nacen  
siempre las cosas mejores.

24  
25

Follow us!



euro3plast



euro3plast

# Noi per Voi

## progettiamo il punto vendita

Analizziamo e definiamo insieme l'ampiezza e le caratteristiche del vostro spazio espositivo, realizzando un progetto personalizzato e pensato su misura per voi.

# Vous et nous

## nous concevons votre point de vente

Nous analysons et définissons ensemble la grandeur et les caractéristiques de votre espace d'exposition.

Nous réalisons un projet personnalisé et pensé sur mesure pour vous.

# Wir Für Sie

## Wir gestalten Ihre Verkaufsstelle

Wir analysieren und definieren gemeinsam mit Ihnen die Größe und Eigenschaften Ihrer Ausstellungsfläche. Wir verwirklichen ein auf Sie zugeschnittenes individuelles Projekt.





## Nosotros para ustedes

diseñamos tu tienda

Analizamos y definimos conjuntamente la amplitud y las características de su espacio expositivo. Realizamos un proyecto personalizado y concebido a medida para ustedes.

## Us for You

we design your store

Together, we analyse and define the size and characteristics of your display area. We create a personalized design to illustrate the installation we have conceived just for you.



## Our ECO-FRIENDLY manifesto

it

Crediamo in un mondo sostenibile, trattiamo l'ambiente con il rispetto dovuto al nostro pianeta e alle future generazioni. Ci impegniamo ad attuare processi produttivi che minimizzino gli sprechi e favoriscano il riciclo. Stiamo attenti a rispettare la natura e sensibilizziamo il nostro personale a fare la raccolta differenziata e ad evitare l'acquisto di prodotti usa e getta.

fr

Nous croyons dans un monde durable, nous traitons l'environnement avec le respect dû à notre planète et aux futures générations. Nous nous engageons à mettre en œuvre des processus de production qui éliminent le gaspillage et favorisent le recyclage. Nous sommes attentifs au respect de l'environnement et sensibilisons notre personnel à faire le tri et à éviter tout achat de produits jetables.

de

Wir glauben an eine nachhaltige Welt und behandeln die Umwelt mit der unserem Planeten und den zukünftigen Generationen gebührenden Achtung. Wir setzen uns für die Implementierung von Produktionsprozessen ein, durch die Abfälle minimiert und das Recycling gefördert werden. Wir kümmern uns um den Umweltschutz und halten unsere Mitarbeiter zur getrennten Mulsammlung und Vermeidung vom Kauf von Einwegprodukten an.



es

Creemos en un mundo sostenible, tratamos las cuestiones medioambientales con el respeto debido a nuestro planeta y a las generaciones futuras. Estamos comprometidos con los procesos de fabricación que minimizan los desperdicios y promueven el reciclaje. Respetamos el medio ambiente y sensibilizamos a nuestro personal para dedicarse a la recogida selectiva de residuos y evitar la compra de productos desechables.

en

We believe in a sustainable world, and treat the environment with the respect we owe to our planet and future generations. We're committed to implementing manufacturing processes that minimize waste and promote recycling. And we take care over respecting nature and enhancing awareness among our staff about recycling, and avoiding buying disposable products.

PASSIONATE BY NATURE

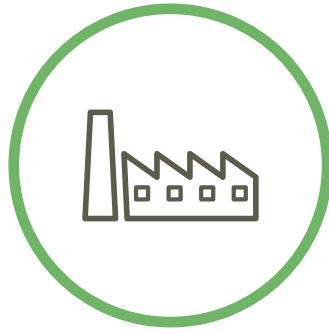

Impianti con sistema di gestione ambientale

Installations avec système de gestion environnementale

Die Produktion erfolgt unter hohen Umweltschutzauflagen

Instalaciones con sistema de gestión medioambiental

Plant and equipment with environmental management system

# OUR GREEN SOUL...

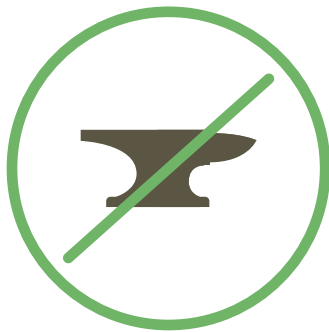

Materie prime e masterbatch privi di metalli pesanti

Matières premières et mélanges-maîtres sans métaux lourds

Rohstoffe und Masterbatches ohne Schwermetalle

Materias primas y concentrados de color sin metales pesados

Raw materials and masterbatches free of heavy metals

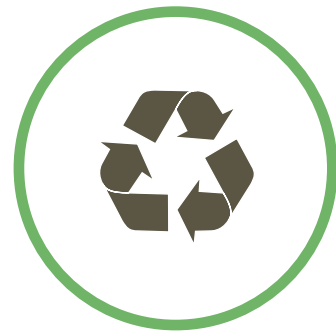

Prodotti riciclabili al 100%

Produits recyclables à 100 %

100 % recycelbare Erzeugnisse

Productos reciclables al 100%

100% recyclable products

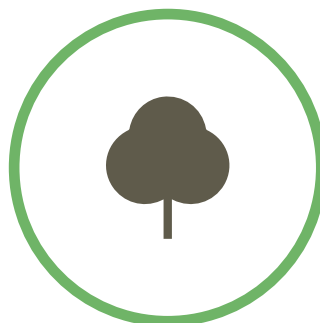

Imballi riciclabili

Emballages recyclables

Recycelbare Verpackungen

Embalajes reciclables

Recyclable packaging



ISO 14001:2015  
La nostra garanzia nei confronti dell'ambiente  
ISO 14001:2015  
Notre garantie pour l'environnement  
ISO 14001:2015  
Garantie der Umwelt gegenüber  
ISO 14001:2015  
Nuestra garantía para con el medio ambiente  
ISO 14001:2015  
Our guarantee for the environment

# ...IS OUR COMMITMENT FOR A BETTER PLANET



Sfridi rigenerati in materia prima  
Déchets régénérés en matière première  
Wiederaufbereitete Abfälle im Rohmaterial  
Recortes regenerados de materia prima  
Waste regenerated into raw material





hobby



100%  
Recyclable



Lightweight



Antishock



U.V.  
Resistant







Temperature  
Resistant





geo | vaso • pot

art.	size				medea 	
1983	Ø 13 (cm 13 x 10 h)	L 0,8	80	1471 • Ø 12	03 G9 62 86 44 01	
1972	Ø 15 (cm 15 x 11 h)	L 1,2	80	1472 • Ø 14	03 G9 62 86 44 01	
1973	Ø 18 (cm 18 x 14 h)	L 2,0	40	1474 • Ø 18	03 G9 62 86 44 01	
1974	Ø 20 (cm 20 x 15 h)	L 2,9	40	1475 • Ø 20	03 M9 G9 62 86 L4 44 01	
1975	Ø 25 (cm 25 x 19 h)	L 5,6	10	1477 • Ø 24	03 M9 G9 62 86 L4 44 01	
1976	Ø 30 (cm 30 x 23 h)	L 9,7	10	1479 • Ø 28	03 M9 G9 62 86 L4 44 01	
1977	Ø 35 (cm 35 x 26 h)	L 15,4	10	1481 • Ø 32	03 M9 G9 62 86 L4 44 01	

# geo

good for plants



pp



vaso con fori  
pot with holes



sottovaso abbinato  
fitting saucer



display solutions



espositore  
display



palbox



3057 total expe  
(cm 63 x 123 x 210 h)

















34  
35

art.	size				medea	
1978	Ø 40	(cm 40 x 30 h)	L 23,2	10	1483 • Ø 40	03 M9 G9 62 86 L4 44 01
1979	Ø 45	(cm 45 x 34 h)	L 33,0	10	1484 • Ø 44	03 M9 G9 62 86 L4 44 01
1980	Ø 50	(cm 50 x 38 h)	L 45,3	10	1485 • Ø 48	03 M9 G9 62 86 L4 44 01
2058	Ø 55	(cm 55 x 41 h)	L 60,4	10	1486 • Ø 52	03 G9 62 01
1981	Ø 60	(cm 60 x 45 h)	L 78,4	5	1487 • Ø 56	03 G9 62 01
1982	Ø 70	(cm 70 x 53 h)	L 124,6	5	1488 • Ø 64	03 G9 62 01

stabile e  
capiente  
stable and  
capacious



guya | vaso • pot

art.	size				medea		
2869	Ø 20 (cm 20 x 15 h)	L 2,8	10	1475 • Ø 20			
2870	Ø 25 (cm 25 x 19 h)	L 5,5	10	1477 • Ø 24			
2871	Ø 30 (cm 30 x 23 h)	L 9,6	10	1479 • Ø 28			
2872	Ø 35 (cm 35 x 26 h)	L 15,4	10	1481 • Ø 32			
2905	Ø 40 (cm 40 x 30 h)	L 23,0	10	1483 • Ø 40			



# guya

good for plants



pp



vaso con fori  
pot with holes



sottovaso abbinato  
fitting saucer



display solutions



espositore  
display







palbox



3057 total expe  
(cm 63 x 123 x 210 h)



cilindro | vaso • pot

art.	size				medea 	
1192	Ø 10	(cm 10 x 7 h)	L 0,3	180	1469 • Ø 8	01
1244	Ø 13	(cm 13 x 9 h)	L 0,7	80	1471 • Ø 12	01
1193	Ø 15	(cm 15 x 11 h)	L 1,0	80	1472 • Ø 14	01
1245	Ø 18	(cm 18 x 13 h)	L 1,8	40	1474 • Ø 18	01
1175	Ø 20	(cm 20 x 14 h)	L 2,5	40	1475 • Ø 20	01
1174	Ø 25	(cm 25 x 18 h)	L 5,0	10	1477 • Ø 24	01
1124	Ø 30	(cm 30 x 21 h)	L 9,0	10	1479 • Ø 28	01

# cilindro

good for plants



pp



vaso con fori  
pot with holes



sottovaso abbinato  
fitting saucer



display solutions



espositore  
display



palbox



2371 iko vasi • pots  
(cm 110 x 110 x 236 h)



38  
39

art.	size				medea		
1112	Ø 35	(cm 35 x 25 h)	L 14	10	1481 • Ø 32		01
1113	Ø 40	(cm 40 x 28 h)	L 21	10	1483 • Ø 40		01
1114	Ø 45	(cm 45 x 31 h)	L 25	10	1484 • Ø 44		01
1125	Ø 50	(cm 50 x 35 h)	L 41	10	1485 • Ø 48		01
1176	Ø 60	(cm 60 x 42 h)	L 70	5	1487 • Ø 56		01
1194	Ø 70	(cm 70 x 49 h)	L 115	5	1488 • Ø 64		01
1300	Ø 90	(cm 90 x 62 h)	L 250	2	1960 • Ø 82		01





robusto e  
capiente

sturdy and  
capacious





coccio | vaso • pot

art.	size				medea 	
1062	Ø 16 (cm 16 x 14 h)	L 1	80	1472 • Ø 14	01	
1063	Ø 18 (cm 18 x 16 h)	L 2	80	1473 • Ø 16	01	
1064	Ø 20 (cm 20 x 17 h)	L 3	80	1474 • Ø 18	69 62 01	
1065	Ø 22 (cm 22 x 19 h)	L 4	80	1475 • Ø 20	01	
1246	Ø 24 (cm 24 x 21 h)	L 6	10	1476 • Ø 22	69 62 01	
1247	Ø 27 (cm 27 x 23 h)	L 8	10	1478 • Ø 26	01	
1248	Ø 30 (cm 30 x 25 h)	L 11	10	1479 • Ø 28	69 62 01	



# coccio

good for plants



pp



vaso con fori  
pot with holes



sottovaso abbinato  
fitting saucer



display solutions



espositore  
display







3057 total expe  
(cm 63 x 123 x 210 h)

art.	size				medea	
1249	Ø 35	(cm 35 x 27 h)	L 18	10	1481 • Ø 32	G9 62 01
1316	Ø 40	(cm 40 x 31 h)	L 25	10	1482 • Ø 36	G9 62 01
1317	Ø 45	(cm 45 x 35 h)	L 34	10	1483 • Ø 40	01
1318	Ø 50	(cm 50 x 38 h)	L 48	10	1485 • Ø 48	01
1394	Ø 60	(cm 60 x 46 h)	L 83	5	1487 • Ø 56	01
1427	Ø 70	(cm 70 x 53 h)	L 132	5	1488 • Ø 64	01



dune | vaso • pot

art.	size				medea 	
1279	Ø 18	(cm 18 x 14 h)	L 1,6	40	1472 • Ø 14	01
1280	Ø 20	(cm 20 x 16 h)	L 2,5	40	1473 • Ø 16	01
1281	Ø 25	(cm 25 x 19 h)	L 5,0	10	1475 • Ø 20	01
1282	Ø 30	(cm 29 x 23 h)	L 8,0	10	1477 • Ø 24	01
1283	Ø 35	(cm 34 x 27 h)	L 13,0	10	1479 • Ø 28	01



# dune

good for plants



pp



vaso con fori  
pot with holes



sottovaso abbinato  
fitting saucer







easy for sales



impilabile  
stackable





42  
43

art.	size				medea	
1284	Ø 40	(cm 39 x 31 h)	L 19,0	10	1481 • Ø 32	01
1285	Ø 45	(cm 44 x 35 h)	L 29,0	10	1482 • Ø 36	01
1286	Ø 50	(cm 49 x 39 h)	L 39,0	10	1483 • Ø 40	01
1287	Ø 60	(cm 59 x 47 h)	L 67,0	5	1485 • Ø 48	01
1288	Ø 70	(cm 68 x 54 h)	L 105,0	5	1487 • Ø 56	01

robusto  
sturdy



linto | vaso • pot

art.	size				medea 	
1662	Ø 14	(cm 14 x 11 h)	L 0,9	80	1470 • Ø 10	01
1663	Ø 16	(cm 16 x 13 h)	L 1,2	80	1471 • Ø 12	01
1664	Ø 18	(cm 18 x 14 h)	L 1,6	40	1472 • Ø 14	01
1665	Ø 20	(cm 20 x 16 h)	L 2,5	40	1473 • Ø 16	01
1666	Ø 25	(cm 25 x 20 h)	L 4,8	10	1475 • Ø 20	01
1667	Ø 30	(cm 30 x 23 h)	L 8,3	10	1477 • Ø 24	01
1668	Ø 35	(cm 35 x 27 h)	L 13,5	10	1479 • Ø 28	01

# linteo

good for plants



pp



vaso con fori  
pot with holes



sottovaso abbinato  
fitting saucer

easy for sales











impilabile  
stackable



art.	size				medea	
1669	Ø 40	(cm 40 x 31 h)	L 19	10	1481 • Ø 32	01
1670	Ø 45	(cm 45 x 35 h)	L 29	10	1482 • Ø 36	01
1671	Ø 50	(cm 50 x 39 h)	L 39	10	1483 • Ø 40	01
1672	Ø 60	(cm 60 x 46 h)	L 67	5	1485 • Ø 48	01
2028	Ø 70	(cm 70 x 51 h)	L 100	5	1487 • Ø 56	01
2029	Ø 85	(cm 85 x 57 h)	L 171	4	1488 • Ø 64	01



garden | vaso • pot

art.	size				moplen	
349	Ø 12 (cm 12 x 10 h)	L 0,6	80	1037 • Ø 10		02
350	Ø 14 (cm 14 x 12 h)	L 0,9	80	1/12 • Ø 12		02
351	Ø 16 (cm 16 x 14 h)	L 1,5	80	1/14 • Ø 14		02
352	Ø 18 (cm 18 x 16 h)	L 2,3	80	1/16 • Ø 16		02
353	Ø 20 (cm 20 x 18 h)	L 3,3	10	1/18 • Ø 18		02



# garden

good for plants



pp



vaso con fori  
pot with holes







sottovaso abbinato  
fitting saucer



easy for sales





impilabile  
stackable

art.	size				moplen	
354	Ø 22	(cm 22 x 19 h)	L 4,4	10	1/18 • Ø 18	02
355	Ø 24	(cm 24 x 21 h)	L 5,5	10	1/22 • Ø 22	02
356	Ø 27	(cm 27 x 22 h)	L 8,0	10	1/24 • Ø 24	02
357	Ø 30	(cm 30 x 23 h)	L 11,0	10	1/26 • Ø 26	02
918	Ø 35	(cm 35 x 26 h)	L 17,0	10	1/30 • Ø 30	02





akea | cassetta • plant box

art.	size				
1680	cm 50	(cm 50 x 28 x 22 h)	L 16	6	03 69 62 01
1681	cm 60	(cm 60 x 31 x 26 h)	L 26	6	03 69 62 01
1683	cm 80	(cm 80 x 39 x 34 h)	L 60	4	03 69 62 01
1684	cm 100	(cm 100 x 46 x 40 h)	L 100	2	03 69 62 01



# akea

good for plants



pp



cassetta con fori  
plant box with holes



sottocassetta abbinata  
fitting oblong tray



easy for sales



vaso abbinato  
matching pot



display solutions



cover pallet

48  
49



akea | sottocassetta • oblong tray

art.	size			
1685	cm 50	(cm 46 x 22 x 3,0 h)	6	03 69 62 01
1686	cm 60	(cm 55 x 26 x 3,7 h)	6	03 69 62 01
1687	cm 80	(cm 73 x 32 x 4,7 h)	4	03 69 62 01
1689	cm 100	(cm 90 x 36 x 5,7 h)	2	03 69 62 01

molto capiente  
very capacious



krea | vaso quadro • square pot

art.	size				
1702	cm 25	(cm 25 x 25 x 22 h)	L 6,5	10	69 62 01
1703	cm 30	(cm 31 x 31 x 26 h)	L 12,0	10	69 62 01
1704	cm 35	(cm 35 x 35 x 30 h)	L 17,0	10	69 62 01
1705	cm 40	(cm 39 x 39 x 34 h)	L 24,0	10	03 69 62 01
1706	cm 45	(cm 46 x 46 x 40 h)	L 38,0	5	03 69 62 01

# krea

good for plants



pp



vaso con fori  
pot with holes



sottovaso abbinato  
fitting saucer



easy for sales



cassetta vaso abbinati  
matching plant box pot

display solutions



cover pallet



50  
51

krea | sottovaso quadro • square saucer

art.	size			
1707	cm 25	(cm 22 x 22 x 3,0 h)	10	G9 62 01
1708	cm 30	(cm 26 x 26 x 3,7 h)	10	G9 62 01
1709	cm 35	(cm 29 x 29 x 4,2 h)	10	G9 62 01
1710	cm 40	(cm 32 x 32 x 4,7 h)	10	03 G9 62 01
1711	cm 45	(cm 36 x 36 x 5,7 h)	5	03 G9 62 01

molto capiente  
very capacious



krea | vaso angolo • angle pot

art.	size				
1743	cm 45	(cm 46 x 46 x 40 h)	L 35	5	01

krea | sottovaso angolo • angle saucer

art.	size			
1745	cm 45	(cm 39 x 39 x 5,7 h)	5	01

# krea

good for plants



pp



vaso con fori  
pot with holes



sottovaso abbinato  
fitting saucer

easy for sales



cassetta vaso abbinati  
matching plant box pot



krea | vaso a muro • wall pot

art.	size				
1742	cm 45 (cm 46 x 38 x 40 h)		L 27	5	01

krea | sottovaso a muro • wall saucer

art.	size			
1744	cm 45 (cm 36 x 30 x 5,7 h)		5	01



inis | cassetta • plant box

art.	size				
1987	cm 40	(cm 40 x 19,5 x 16,4 h)	L 8	12	03 M9 G9 62 86 18 44 01
1988	cm 50	(cm 50 x 19,5 x 16,4 h)	L 10	12	03 M9 G9 62 86 18 44 01
1989	cm 60	(cm 60 x 19,5 x 16,4 h)	L 12	12	03 M9 G9 62 86 18 44 01
2055	cm 80	(cm 80 x 19,5 x 16,4 h)	L 17	6	03 M9 G9 62 86 18 44 01



# inis

good for plants



pp



cassetta con fori  
plant box with holes





sottocassetta abbinata  
fitting oblong tray

display solutions



palbox

## inis | sottocassetta • oblong tray



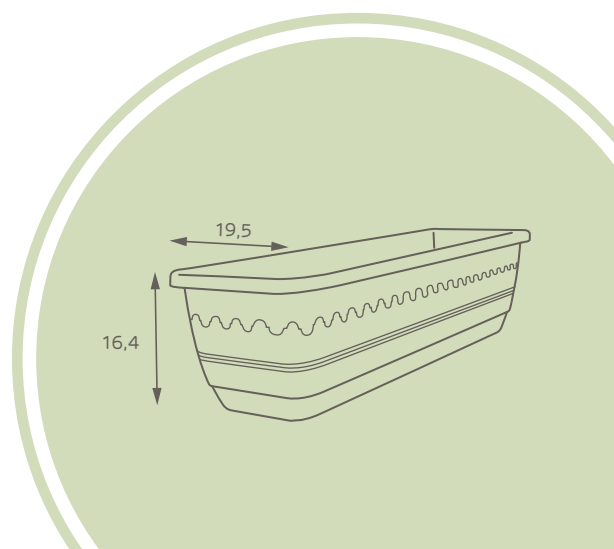



art.	size			
1990	cm 40	(cm 36,6 x 16,1 x 3 h)	12	03 M9 G9 62 86 18 44 01
1991	cm 50	(cm 46,6 x 16,1 x 3 h)	6	03 M9 G9 62 86 18 44 01
1992	cm 60	(cm 56,6 x 16,1 x 3 h)	12	03 M9 G9 62 86 18 44 01
2056	cm 80	(cm 76,6 x 16,1 x 3 h)	6	03 M9 G9 62 86 18 44 01







gardenie | cassetta • plant box

art.	size				
2327	cm 40	(cm 40 x 20 x 16 h)	L 8	24	
2328	cm 50	(cm 50 x 20 x 16 h)	L 10	24	
2329	cm 60	(cm 60 x 20 x 16 h)	L 12	24	



# gardenie

good for plants



pp



cassetta con fori  
plant box with holes



sottocassetta abbinata  
fitting oblong tray





easy for sales





impilabile  
stackable

gardenie | sottocassetta • oblong tray



art.	size			
2330	cm 40	(cm 37 x 17 x 2,7 h)	24	G9 62 02 01 75
2331	cm 50	(cm 47 x 17 x 2,7 h)	24	G9 62 02 01 75
2332	cm 60	(cm 57 x 17 x 2,7 h)	24	G9 62 02 01 75



gerani | cassetta • plant box



art.	size				
1017	cm 30	(cm 30 x 17 x 14 h)	L 5	25	02 01
1018	cm 35	(cm 35 x 17 x 14 h)	L 6	25	02 01
1019	cm 40	(cm 40 x 17 x 14 h)	L 7	25	03 02 01
1020	cm 50	(cm 50 x 17 x 14 h)	L 9	25	03 02 01
1021	cm 60	(cm 60 x 17 x 14 h)	L 11	25	03 02 01

gerani | sottocassetta • oblong tray



art.	size			
1067	cm 30	(cm 26 x 13 x 3 h)	25	02 01
1068	cm 35	(cm 31 x 13 x 3 h)	25	02 01
1069	cm 40	(cm 36 x 13 x 3 h)	25	03 02 01
1070	cm 50	(cm 46 x 13 x 3 h)	25	03 02 01
1071	cm 60	(cm 56 x 13 x 3 h)	25	03 02 01



garden | sottocassetta • oblong tray











art.	size			
360	cm 30	(cm 29 x 16 x 2 h)	50	02 01
361	cm 35	(cm 34 x 16 x 2 h)	50	02 01
362	cm 40	(cm 39 x 16 x 2 h)	50	03 02 01
363	cm 50	(cm 49 x 16 x 2 h)	50	03 02 01
364	cm 60	(cm 59 x 16 x 2 h)	50	03 02 01

pedino | pedino • little base

art.			
1462	(cm 7,7 x 4,1 x 4,9 h)	40	62 01 45



**kalis** | cassetta • plant box

art.	size				
1941	<b>cm 50</b>	(cm 50 x 25 x 21 h)	L 16	12	 
1888	<b>cm 60</b>	(cm 60 x 25 x 21 h)	L 20	12	 
1889	<b>cm 80</b>	(cm 80 x 25 x 21 h)	L 28	6	 
1890	<b>cm 100</b>	(cm 100 x 25 x 21 h)	L 35	6	 



# kalis

good for plants



pp



cassetta con fori  
plant box with holes



sottocassetta abbinata  
fitting oblong tray









easy for sales



impilabile  
stackable

60  
61

kalis | sottocassetta • oblong tray



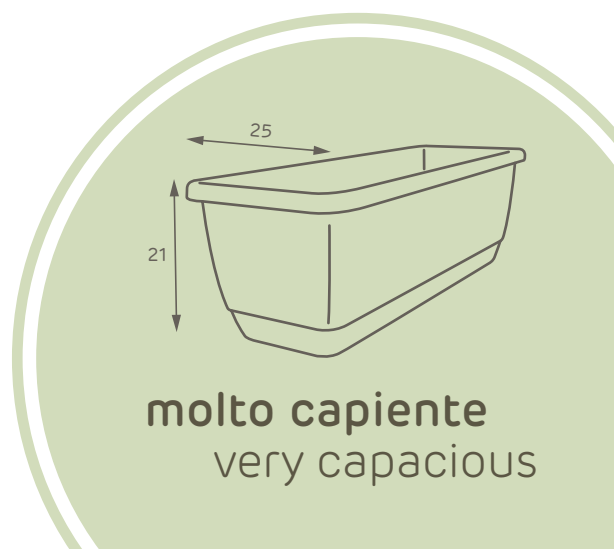

art.	size			
1942	cm 50	(cm 45,6 x 20,6 x 3,5 h)	12	
1891	cm 60	(cm 55,6 x 20,6 x 3,5 h)	12	
1892	cm 80	(cm 75,6 x 20,6 x 3,5 h)	6	
1893	cm 100	(cm 95,6 x 20,6 x 3,5 h)	6	



molto capiente  
very capacious



**kalis** | cassetta con riserva d'acqua • plant box with water reserve

art.	size					
1894	<b>cm 60</b>	(cm 60 x 25 x 21 h)	L 17,4	L 2,6	6	01
1895	<b>cm 80</b>	(cm 80 x 25 x 21 h)	L 24,8	L 3,2	6	01
1896	<b>cm 100</b>	(cm 100 x 25 x 21 h)	L 30,8	L 4,2	6	01

# kalis

good for plants



pp



easy for sales



impilabile  
stackable



62  
63

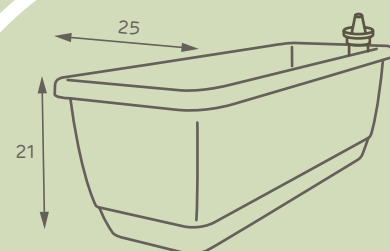



con riserva d'acqua  
with water reserve





**dune** | cassetta con sottocassetta montata • plant box with attached oblong tray

art.	size				
2338	<b>cm 40</b>	(cm 40 x 20 x 18 h)	L 8	12	03 01
2339	<b>cm 50</b>	(cm 50 x 20 x 18 h)	L 10	12	03 01
2340	<b>cm 60</b>	(cm 60 x 20 x 18 h)	L 12	12	03 01
2341	<b>cm 80</b>	(cm 80 x 20 x 18 h)	L 17	6	03 01



# dune

good for plants



pp



sottocassetta montata  
attached oblong tray



easy for sales



impilabile  
stackable

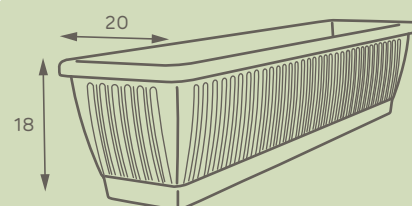

64  
65



**robusto**  
sturdy



licum | cassetta con sottocassetta montata • plant box with attached oblong tray

art.	size				
1999	cm 20	(cm 20 x 12,5 x 10,8 h)	L 1,5	12	03 02 01
2000	cm 30	(cm 30 x 12,5 x 10,8 h)	L 2,5	12	03 02 01
2001	cm 40	(cm 40 x 12,5 x 10,8 h)	L 3,0	12	03 02 01



# licum

good for plants



pp



sottocassetta montata  
attached oblong tray

display solutions





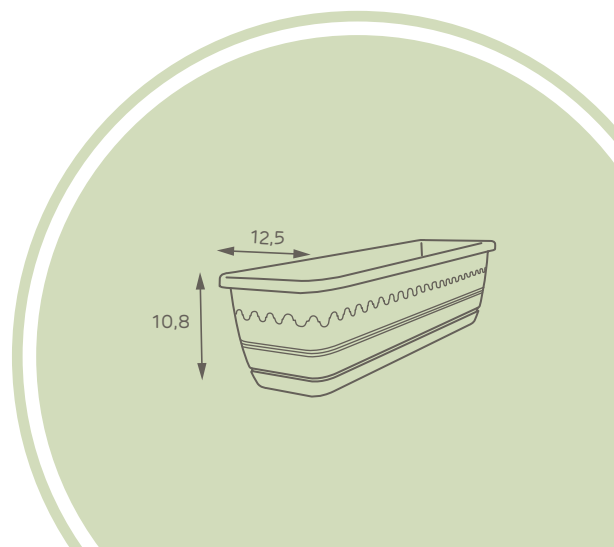



palbox





miza | cassetta • plant box

art.	size				
1897	cm 40	(cm 40 x 21,7 x 18 h)	L 10	12	
1898	cm 50	(cm 50 x 21,7 x 18 h)	L 13	12	
1899	cm 60	(cm 60 x 21,7 x 18 h)	L 16	12	



# miza

good for plants



pp



cassetta con fori  
plant box with holes



sottocassetta abbinata  
fitting oblong tray





easy for sales



impilabile  
stackable

68  
69

miza | sottocassetta • oblong tray

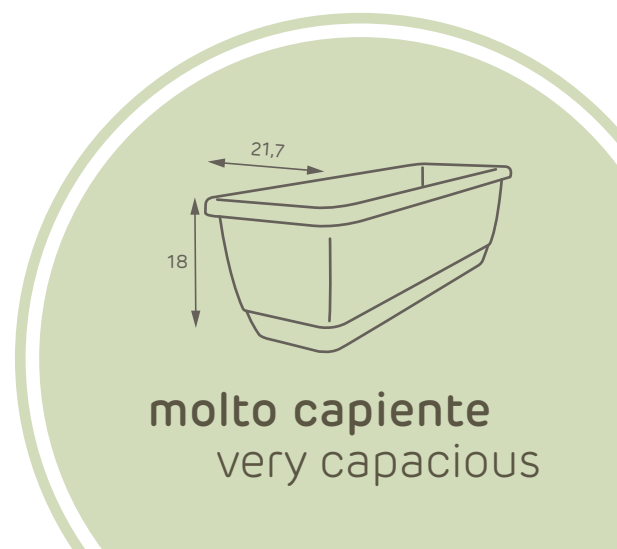

art.	size			
1900	cm 40	(cm 36 x 17,9 x 3 h)	12	
1901	cm 50	(cm 46 x 17,9 x 3 h)	12	
1902	cm 60	(cm 56 x 17,9 x 3 h)	12	



molto capiente  
very capacious



kezar | cassetta con sottocassetta montata • plant box with attached oblong tray

art.	size				
2333	cm 40	(cm 40 x 20 x 18 h)	L 8	12	<b>G9 62 01 75</b>
2334	cm 50	(cm 50 x 20 x 18 h)	L 10	12	<b>G9 62 01 75</b>
2335	cm 60	(cm 60 x 20 x 18 h)	L 12	12	<b>G9 62 01 75</b>
2336	cm 80	(cm 80 x 20 x 18 h)	L 17	6	<b>G9 62 01 75</b>
2337	cm 100	(cm 100 x 20 x 18 h)	L 21	6	<b>01 75</b>



# kezar

good for plants



pp



sottocassetta montata  
attached oblong tray

display solutions



espositore  
display





3069 kai  
(cm 65 x 90 x 183 h)





rigata | cassetta • plant box

art.	size				
1202	cm 80	(cm 82 x 41 x 33 h)	L 79	4	01
1205	cm 100	(cm 98 x 46 x 42 h)	L 128	2	01

# rigata

good for plants



pp



sottocassetta abbinata  
fitting oblong tray



easy for sales



impilabile  
stackable



72  
73

maxi | sottocassetta • oblong tray



















art.	size			
1168	cm 80	(cm 82 x 39 x 4 h)	4	01
1191	cm 90	(cm 90 x 40 x 5 h)	2	01

robusta e  
capiente

sturdy and  
capacious



olimpo | ciotola • plant bowl

art.	size				medea 	
1375	Ø 20	(cm 20 x 8 h)	L 1,4	20	1474 • Ø 18	  
1376	Ø 25	(cm 25 x 9 h)	L 2,7	20	1476 • Ø 22	  
1359	Ø 30	(cm 30 x 11 h)	L 4,7	20	1478 • Ø 26	  
1454	Ø 35	(cm 35 x 13 h)	L 7,5	20	1481 • Ø 32	  
1360	Ø 40	(cm 40 x 15 h)	L 11,0	20	1482 • Ø 36	  



# olimpo

good for plants



pp



vaso con fori  
pot with holes





sottovaso abbinato  
fitting saucer



easy for sales

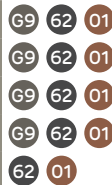

impilabile  
stackable

art.	size				medea	
1500	Ø 45 (cm 45 x 17 h)	L 16	10	1483 • Ø 40	G9 62 01	
1361	Ø 50 (cm 50 x 19 h)	L 22	10	1484 • Ø 44	G9 62 01	
1362	Ø 60 (cm 60 x 23 h)	L 38	10	1485 • Ø 48	G9 62 01	
1363	Ø 70 (cm 70 x 27 h)	L 60	5	1487 • Ø 56	G9 62 01	
1455	Ø 90 (cm 90 x 34 h)	L 128	2	1960 • Ø 82	62 01	



libis | ciotola con sottovaso montato • plant bowl with attached saucer

art.	size				
2427	Ø 25	(cm 25 x 11 h)	L 3,6	12	M9 G9 62 L4 01 75 69
2428	Ø 30	(cm 30 x 13 h)	L 6,4	12	M9 G9 62 L4 01 75 69
2429	Ø 35	(cm 35 x 15 h)	L 10,0	12	M9 G9 62 L4 01 75 69



# libis

good for plants



pp



sottovaso montato  
attached saucer

display solutions



espositore  
display























palbox



3068 lis  
(cm 65 x 86 x 183 h)









**eolia** | ciotola con sottovaso montato •  
plant bowl with attached saucer

art.	size				
1908	Ø 23	(cm 23 x 13 h)	L 3,2	24	  
1909	Ø 28	(cm 28 x 14 h)	L 5,3	24	  
1910	Ø 32	(cm 32 x 16 h)	L 7,7	12	  
1911	Ø 38	(cm 38 x 18 h)	L 12,3	12	  
1957	Ø 43	(cm 43 x 20 h)	L 17,8	6	  
2059	Ø 48	(cm 48 x 23 h)	L 24,5	6	  









**eolia** | ciotola appesa con sottovaso montato •  
hanging plant bowl with attached saucer

art.	size				
1912	Ø 19	(cm 19 x 13 h)	L 1,8	12	
1913	Ø 23	(cm 23 x 15 h)	L 3,2	12	
1914	Ø 28	(cm 28 x 17 h)	L 5,3	12	
1915	Ø 32	(cm 32 x 19 h)	L 7,7	6	





**azem** | ciotola appesa con sottovaso montato •  
hanging plant bowl with attached saucer

art.	size				
2021	Ø 25	(cm 25 x 18 h)	L 3,2	6	
2022	Ø 30	(cm 30 x 21 h)	L 5,7	6	
2023	Ø 35	(cm 35 x 25 h)	L 9,0	6	





azem | fioriera • vase

art.	size				
2010	Ø 30	(cm 30 x 28 h)	L 5,7	12	01 59
2011	Ø 35	(cm 35 x 33 h)	L 9,0	6	01 59
2012	Ø 40	(cm 40 x 38 h)	L 13,5	6	01 59
2013	Ø 45	(cm 45 x 42 h)	L 20,5	6	01 59





olimpo | gerla con sottovaso •  
wall pot with saucer

art.	size				
1802	cm 25	(cm 25 x 16 x 18 h)	L 2,9	24	01
1803	cm 30	(cm 30 x 19 x 21 h)	L 5,1	24	01



domus | gerla con sottovaso •  
wall pot saucer

art.	size				
1800	cm 25	(cm 25 x 16 x 18 h)	L 2,9	24	01
1801	cm 30	(cm 30 x 19 x 21 h)	L 5,1	24	01





medea | sottovaso • saucer

art.	size											
1469	Ø 8	(cm 9,6 x 1,6 h)	1192								200	01
1470	Ø 10	(cm 11,0 x 1,8 h)						1662			200	01
1471	Ø 12	(cm 12,8 x 2,1 h)	1244			1983		1663			200	03 G9 62 86 44 01
1472	Ø 14	(cm 14,3 x 2,4 h)	1193	1062	1279	1972		1664			200	03 G9 62 86 44 01
1473	Ø 16	(cm 15,9 x 2,6 h)		1063	1280			1665			100	01
1474	Ø 18	(cm 17,9 x 2,9 h)	1245	1064		1973			1375		100	03 G9 62 86 44 01
1475	Ø 20	(cm 20,0 x 3,3 h)	1175	1065	1281	1974	2869	1666			100	03 T2 M9 G9 62 86 L4 44 T1 01
1476	Ø 22	(cm 22,0 x 3,6 h)		1246					1376		100	G9 62 01
1477	Ø 24	(cm 23,9 x 3,7 h)	1174		1282	1975	2870	1667			100	03 T2 M9 G9 62 86 L4 44 T1 01
1478	Ø 26	(cm 26,0 x 3,9 h)		1247					1359		100	G9 62 01
1479	Ø 28	(cm 27,9 x 4,2 h)	1124	1248	1283	1976	2871	1668			50	03 T2 M9 G9 62 86 L4 44 T1 01



# medea

good for plants



pp

display solutions



espositore  
display



2154 tree  
(cm 100 x 100 x 212 h)









2652 iko sottovasi • saucers  
(cm 100 x 100 x 192 h)

art.	size		cilindro	coccio	dune	geo	guya	linto	olimp			
1480	Ø 30	(cm 30 x 4,4 h)									50	G9 01
1481	Ø 32	(cm 32 x 4,6 h)	1112	1249	1284	1977	2872	1669	1454		50	03 T2 M9 G9 62 86 L4 44 T1 01
1482	Ø 36	(cm 36 x 5,0 h)		1316	1285			1670	1360		50	G9 62 01
1483	Ø 40	(cm 40 x 5,4 h)	1113	1317	1286	1978	2905	1671	1500		50	03 T2 M9 G9 62 86 L4 44 T1 01
1484	Ø 44	(cm 44 x 5,8 h)	1114			1979			1361		24	03 M9 G9 62 86 L4 44 01
1485	Ø 48	(cm 48 x 6,2 h)	1125	1318	1287	1980		1672	1362		25	03 M9 G9 62 86 L4 44 01
1486	Ø 52	(cm 52 x 6,7 h)				2058					24	03 G9 62 01
1487	Ø 56	(cm 56 x 6,9 h)	1176	1394	1288	1981		2028	1363		25	03 G9 62 01
1488	Ø 64	(cm 64 x 7,0 h)	1194	1427		1982		2029			15	03 G9 62 01
1960	Ø 82	(cm 82 x 8,7 h)	1300						1455		5	01



sottovaso con ruote | sottovaso con ruote montate • saucer with attached wheels

art.	size		cilindro 	coccio 	dune 	geo 	linteo 		
1954	Ø 21	(cm 21,1 x 9,2 h)	1174	1246	1282	1975	1667	6	98 01
1107	Ø 25	(cm 24,8 x 10,8 h)	1124	1247	1283	1976	1668	6	98 01
1108	Ø 28	(cm 27,8 x 11,0h)		1248	1284		1669	6	01
1109	Ø 31	(cm 30,3 x 11,1 h)	1112	1249	1285	1977	1670	6	98 01
1110	Ø 35	(cm 35,4 x 11,4 h)	1113	1316	1286	1978	1671	6	01
1955	Ø 39	(cm 39,0 x 12,0 h)	1114	1317		1979		6	01
1111	Ø 42	(cm 42,0 x 12,0 h)	1125	1318	1287	1980	1672	6	01
1661	Ø 48	(cm 48,4 x 12,2 h)	1176	1394	1288	2058	2028	6	01
1956	Ø 56	(cm 56,0 x 13,1 h)	1194	1427		1982	2029	6	01

# sottovaso con ruote

good for plants



pp



easy for sales



impilabile  
stackable





82  
83



portata  
elevata  
high load  
capacity



**sabbiato** | sottovaso •  
saucer

















art.	size			
1313	Ø 6	(cm 6,0 x 1,3 h)	200	01
1314	Ø 8	(cm 8,0 x 1,5 h)	200	01
1229	Ø 10	(cm 9,0 x 1,4 h)	200	01
3/12	Ø 12	(cm 12,0 x 2,4 h)	200	01
3/14	Ø 14	(cm 14,0 x 2,7 h)	200	01
3/16	Ø 16	(cm 16,2 x 2,9 h)	100	01
3/18	Ø 18	(cm 18,0 x 3,2 h)	100	01
3/20	Ø 20	(cm 20,0 x 3,4 h)	100	01
3/22	Ø 22	(cm 22,0 x 3,7 h)	100	01
3/24	Ø 24	(cm 24,0 x 4,0 h)	100	01
3/26	Ø 26	(cm 26,0 x 4,2 h)	100	01
3/28	Ø 28	(cm 28,0 x 4,4 h)	50	01
3/30	Ø 30	(cm 30,0 x 4,7 h)	50	01
3/35	Ø 35	(cm 35,0 x 5,0 h)	50	01
3/40	Ø 40	(cm 40,0 x 5,3 h)	50	01
3/45	Ø 45	(cm 45,0 x 5,5 h)	50	01
3/50	Ø 50	(cm 50,0 x 5,2 h)	25	01
3/55	Ø 55	(cm 58,6 x 5,8 h)	25	01
3/60	Ø 60	(cm 63,6 x 6,0 h)	25	01

**moplen** | sottovaso •  
saucer









art.	size			
1037	Ø 10	(cm 10,0 x 2,3 h)	200	03 02
1/12	Ø 12	(cm 11,9 x 2,5 h)	200	03 02
1/14	Ø 14	(cm 13,9 x 2,9 h)	200	03 02
1/16	Ø 16	(cm 15,7 x 3,1 h)	100	03 02
1/18	Ø 18	(cm 17,9 x 3,3 h)	100	03 02
1/20	Ø 20	(cm 19,8 x 3,5 h)	100	03 02
1/22	Ø 22	(cm 21,9 x 3,6 h)	100	03 02
1/24	Ø 24	(cm 23,9 x 3,9 h)	100	03 02
1/26	Ø 26	(cm 25,9 x 4,2 h)	100	03 02
1/28	Ø 28	(cm 27,9 x 4,5 h)	50	03 02
1/30	Ø 30	(cm 29,8 x 4,7 h)	50	02
1/35	Ø 35	(cm 34,9 x 5,0 h)	50	02
1/40	Ø 40	(cm 39,9 x 5,2 h)	50	02
1/45	Ø 45	(cm 45,0 x 5,5 h)	50	02
1/50	Ø 50	(cm 49,8 x 5,6 h)	25	02



**air** | sottovaso trasparente •  
transparent saucer



art.	size			
2619	<b>Ø 10</b>	(cm 10,0 x 2,3 h)	200	
2620	<b>Ø 12</b>	(cm 11,9 x 2,5 h)	200	
2621	<b>Ø 14</b>	(cm 13,9 x 2,9 h)	200	
2622	<b>Ø 16</b>	(cm 15,7 x 3,1 h)	100	
2623	<b>Ø 18</b>	(cm 17,9 x 3,3 h)	100	
2624	<b>Ø 20</b>	(cm 19,8 x 3,5 h)	100	
2625	<b>Ø 22</b>	(cm 21,9 x 3,6 h)	50	
2626	<b>Ø 24</b>	(cm 23,9 x 3,9 h)	50	
2627	<b>Ø 26</b>	(cm 25,9 x 4,2 h)	50	
2628	<b>Ø 28</b>	(cm 27,9 x 4,5 h)	50	
2629	<b>Ø 30</b>	(cm 29,8 x 4,7 h)	50	
2630	<b>Ø 35</b>	(cm 34,9 x 5,0 h)	50	
2631	<b>Ø 40</b>	(cm 39,9 x 5,2 h)	50	
2632	<b>Ø 45</b>	(cm 45,0 x 5,5 h)	50	
2633	<b>Ø 50</b>	(cm 49,8 x 5,6 h)	25	

**dekus air** | sottovaso quadro trasparente •  
square transparent saucer



art.	size			
2613	<b>cm 14</b>	(cm 14 x 14 x 2,3 h)	20	
2614	<b>cm 19</b>	(cm 19 x 19 x 3,1 h)	20	
2615	<b>cm 23</b>	(cm 23 x 23 x 3,8 h)	20	
2616	<b>cm 27</b>	(cm 27 x 27 x 4,5 h)	20	
2617	<b>cm 32</b>	(cm 32 x 32 x 5,2 h)	20	
2618	<b>cm 39</b>	(cm 39 x 39 x 6,3 h)	20	



**quadro** | sottovaso quadro • square saucer



art.	size			
1170	<b>cm 29</b>	(cm 28 x 28 x 4 h)	10	<b>01</b>
1171	<b>cm 34</b>	(cm 33 x 33 x 4 h)	10	<b>01</b>
1172	<b>cm 39</b>	(cm 38 x 38 x 5 h)	10	<b>01</b>
1173	<b>cm 47</b>	(cm 47 x 47 x 5 h)	10	<b>01</b>

**mini** | sottocassetta • oblong tray



art.	size			
1238	<b>cm 30</b>	(cm 30 x 16 x 4 h)	25	<b>01</b>
1239	<b>cm 35</b>	(cm 35 x 17 x 5 h)	25	<b>01</b>
1240	<b>cm 40</b>	(cm 41 x 18 x 5 h)	25	<b>01</b>
1241	<b>cm 46</b>	(cm 47 x 20 x 5 h)	25	<b>01</b>
1242	<b>cm 52</b>	(cm 53 x 22 x 6 h)	25	<b>01</b>
1243	<b>cm 62</b>	(cm 63 x 23 x 7 h)	25	<b>01</b>



**maxi | sottocassetta • oblong tray**

art.	size			
1228	<b>cm 50</b>	(cm 49 x 25 x 4 h)	6	01
1186	<b>cm 60</b>	(cm 63 x 30 x 4 h)	6	01
1167	<b>cm 70</b>	(cm 74 x 35 x 4 h)	6	01
1168	<b>cm 80</b>	(cm 82 x 39 x 4 h)	4	01
1191	<b>cm 90</b>	(cm 90 x 40 x 5 h)	2	01
1169	<b>cm 100</b>	(cm 101 x 47 x 5 h)	6	01

**moplen | sottocassetta • oblong tray**

art.	size			
2/25	<b>cm 25</b>	(cm 25 x 15 x 4,0 h)	25	02
2/30	<b>cm 30</b>	(cm 30 x 16 x 4,0 h)	25	02
2/35	<b>cm 35</b>	(cm 35 x 17 x 5,0 h)	25	02
2/40	<b>cm 40</b>	(cm 40 x 18 x 5,0 h)	25	02
2/46	<b>cm 46</b>	(cm 46 x 20 x 5,0 h)	25	02
2/52	<b>cm 52</b>	(cm 52 x 22 x 5,9 h)	25	02
2/62	<b>cm 62</b>	(cm 63 x 20 x 5,8 h)	25	02



# home



100%  
Recyclable



Lightweight



Antishock



U.V.  
Resistant



Temperature  
Resistant







**tuit** | vaso con container • pot with container

art.	size						
2785	Ø 33 (cm 33 x 61 h)	L 38,0	L 16	A4374	4		
2858	Ø 40 (cm 40 x 75 h)	L 69,5	L 29	A4430	2		

# tuit

good for plants



pp



kit riserva d'acqua  
water reserve kit



display solutions



cover pallet



90  
91

Eleganti e funzionali sono adatti per arredare sia ambienti indoor che outdoor e per essere utilizzati sia come vasi che come coprivasi.

Both elegant and functional, they are ideal to furnish both indoor and outdoor settings, and to be used both as pots and as cachepots.

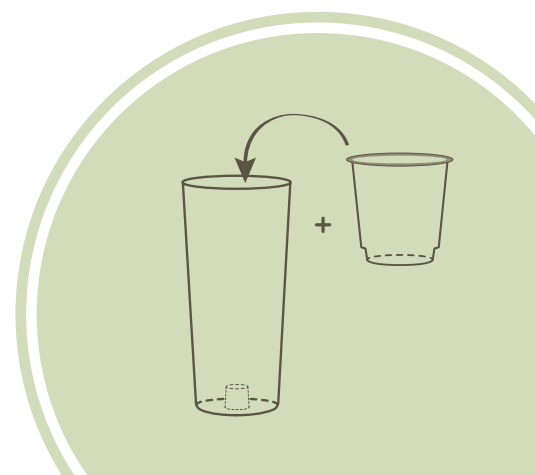



**tuit laccato opaco** | vaso laccato opaco con container • matt lacquered pot with container

art.	size						
3047	Ø 33	(cm 33 x 61 h)	L 38	L 16	A4374	4	



# tuit

laccato opaco • matt lacquered

good for **plants**



pp



kit riserva d'acqua  
water reserve kit

**display** solutions



cover pallet

**Sottoposti a un accurato processo di laccatura, si vestono di una esclusiva finitura opaca.**

Having received an elaborate lacquering process, they have a precious matt finish

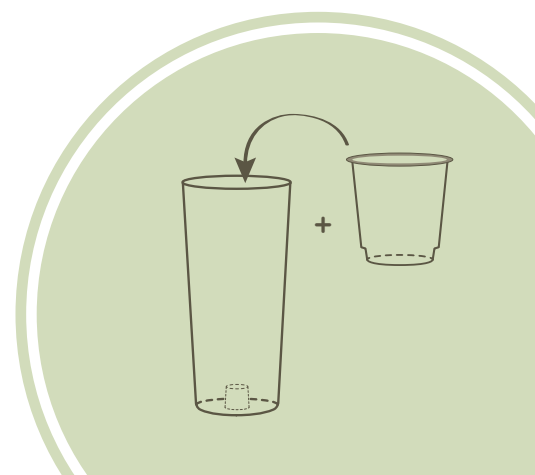



tuit krome | vaso con container • pot with container

art.	size						
3046	Ø 33	(cm 33 x 61 h)	L 38	L 16	A4374	4	  



# tuit

## krome

good for **plants**



pp



kit riserva d'acqua  
water reserve kit

**display** solutions



cover pallet

94  
95

Sottoposti a un particolare processo di metallizzazione sottovuoto dell'alluminio, si vestono di un sottile strato di metallo che li trasforma in eleganti sculture riflettenti.

By undergoing a special process of aluminium vacuum metalization, they are dressed in a thin layer of metal that transforms them into elegant reflective sculptures.

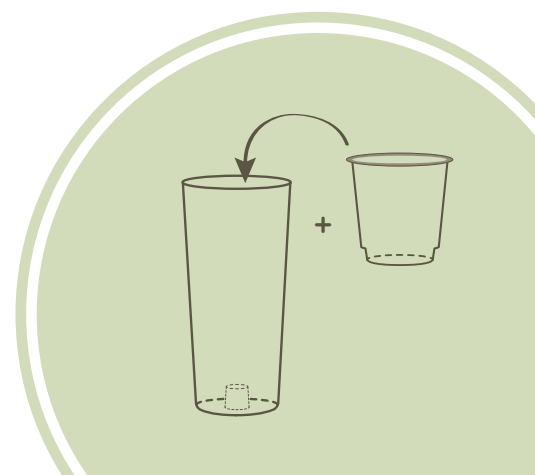





duo | vaso con container • pot with container

art.	size					
3 0 13	Ø 38	(cm 39 x 80 h)	L 57	L 27	2	

# duo

good for **plants**



pp

**display** solutions



cover pallet



96  
97

**Eleganti e funzionali sono adatti per arredare sia ambienti indoor che outdoor e per essere utilizzati sia come vasi che come coprivasi.**

Both elegant and functional, they are ideal to furnish both indoor and outdoor settings, and to be used both as pots and as cachepots.

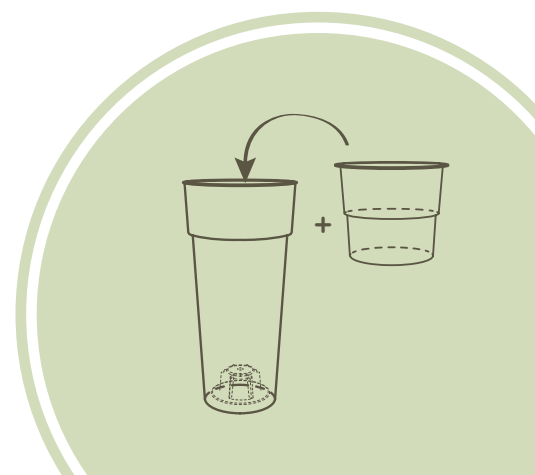



**duo** | con container • with container light (indoor/outdoor)

art.	size		
2987	Ø 38	(cm 39 x 80 h)	1 

La serie DUO in versione light non può essere allestito con terra, piante, vasi o con oggetti vari.  
The light version of the DUO series cannot be set up with soil, plants, vases or various other objects.



# duo

---

## light

material



PP

easy for sales



kit luce montato  
installed light kit

**Funzionale di giorno e scenografico di notte, è dotato di un kit illuminante outdoor garantito e certificato.**

The lamp functional in daytime and spectacular at night, has a guaranteed, certified outdoor lighting kit.



**duo** | vaso quadro con container • square pot with container

art.	size					
3014	cm 37	(cm 38 x 38 x 80 h)	L 69	L 32	2	

# duo

good for plants



pp

display solutions



cover pallet



100  
101

**Eleganti e funzionali sono adatti per arredare sia ambienti indoor che outdoor e per essere utilizzati sia come vasi che come coprivasi.**

Both elegant and functional, they are ideal to furnish both indoor and outdoor settings, and to be used both as pots and as cachepots.

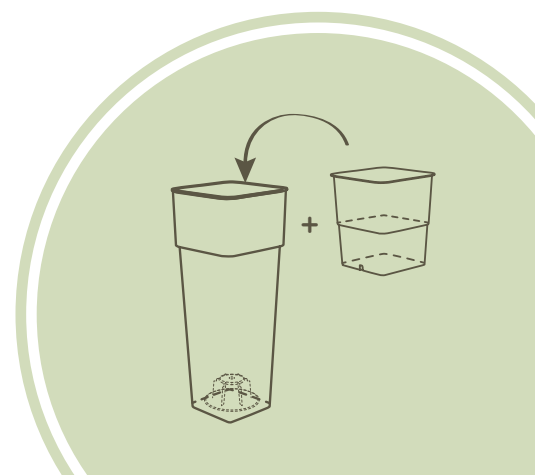



**duo** | quadro con container • square with container light (indoor/outdoor)

art.	size			
2991	<b>cm 37</b>	(cm 38 x 38 x 80 h)	1	98

La serie DUO in versione light non può essere allestito con terra, piante, vasi o con oggetti vari.  
The light version of the DUO series cannot be set up with soil, plants, vases or various other objects.



# duo

---

## light

material



PP

easy for sales



kit luce montato  
installed light kit

**Funzionale di giorno e scenografico di notte, è dotato di un kit illuminante outdoor garantito e certificato.**

The lamp functional in daytime and spectacular at night, has a guaranteed, certified outdoor lighting kit.





up | vaso con riserva d'acqua • pot with water reserve

art.	size					
2988	Ø 25	(cm 25 x 20 x 23 h)	L 4	L 0,35	6	



up

good for plants



pp

display solutions



espositore  
display



palbox



3064 global expe  
(cm 56 x 56 x 183 h)

104  
105

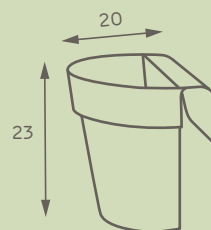

con riserva d'acqua  
with water reserve



up | cassetta • plant box

art.	size				
3059	cm 50	(cm 50 x 21 x 23 h)	L 9	6	

# up

good for plants



pp



display solutions



espositore display



palbox



3064 global expe  
(cm 56 x 56 x 183 h)



106  
107

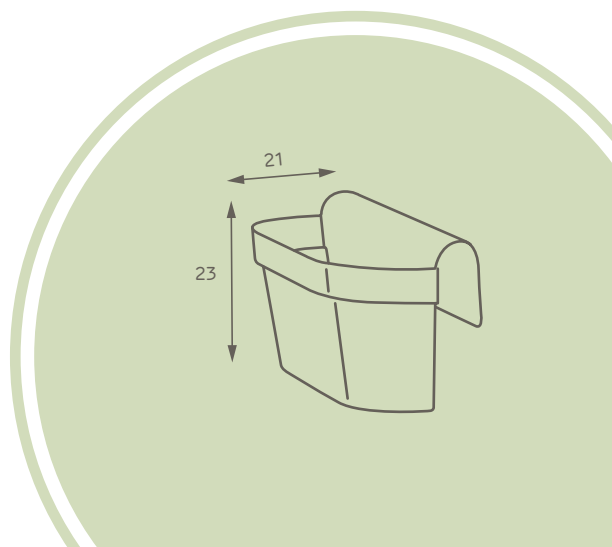



be up | vaso con riserva d'acqua • pot with water reserve

art.	size					
3032	Ø 25	(cm 33 x 25 x 25 h)	L 8	L 0,70	6	



# be up

good for plants



pp



display solutions



espositore  
display



palbox



3064 global expe  
(cm 56 x 56 x 183 h)

108  
109

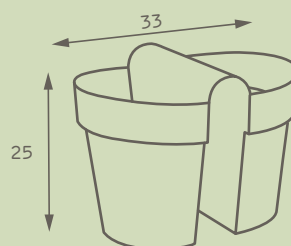

con riserva d'acqua  
with water reserve



be up | cassetta • plant box

art.	size				
3048	cm 50	(cm 49,5 x 33 x 23 h)	L 18	4	

# be up

good for plants



pp



display solutions



espositore  
display



palbox



3064 global expe  
(cm 56 x 56 x 183 h)



110  
111

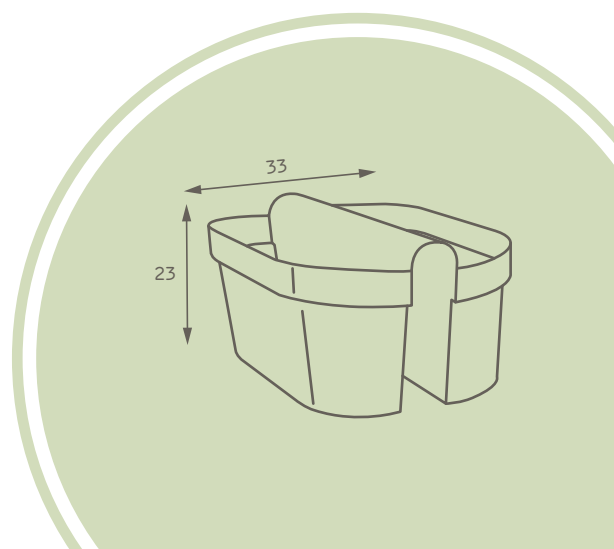





**mitu pac** | cassetta con fori • plant box with holes

art.	size				
2915	cm 100	(cm 99 x 40 x 40 h)	L 112	2	03 M9 69 62 44 N0

# mitu pac

good for **plants**



pp

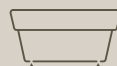

**cassetta con fori**  
plant box with holes



**sottocassetta abbinata**  
fitting oblong tray



easy for **sales**



**vaso abbinato**  
matching pot



**display solutions**



cover pallet

112  
113

akea | sottocassetta • oblong tray

art.	size			
1689	cm 100	(cm 90 x 36 x 5,7 h)	2	03 M9 G9 62 44 NO

**molto capiente**  
very capacious



mitu pac quadro | vaso con fori • pot with holes

art.	size				
2914	cm 40	(cm 40 x 40 x 40 h)	L 41	2	



# mitu pac

good for plants



pp



vaso con fori  
pot with holes



sottovaso abbinato  
fitting saucer



easy for sales



cassetta abbinata  
matching plant box

display solutions



cover pallet

114  
115

krea | sottovaso quadro • square saucer

art.	size			
1711	cm 45	(cm 36 x 36 x 5,7 h)	5	03 M9 G9 62 N1 L4

molto capiente  
very capacious



mitu pac | cassetta con fori • plant box with holes

art.	size				
2886	cm 50	(cm 50 x 18 x 16,5 h)	L 10,5	6	

# mitu pac

good for **plants**



pp



**cassetta con fori**  
plant box with holes



**sottocassetta abbinata**  
fitting oblong tray

easy for **sales**



**impilabile**  
stackable



116  
117

inis | sottocassetta • oblong tray

art.	size			
1991	cm 50	(cm 46,6 x 16,1 x 3 h)	6	

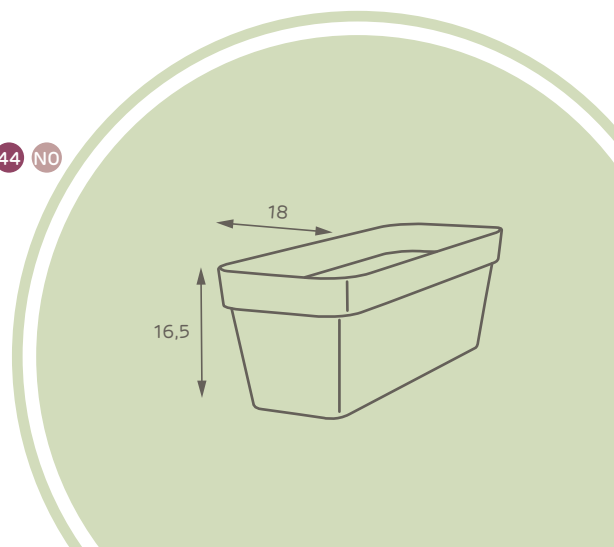



**mitu pac** | cassetta con riserva d'acqua • plant box with water reserve

art.	size						
2907	cm 50	(cm 50 x 18 x 16,5 h)	L 9,5	L1	A4467	6	

# mitu pac

good for **plants**



PP



easy for **sales**



impilabile  
stackable



118  
119





con riserva d'acqua  
with water reserve





mitu pac | vaso con fori • pot with holes

art.	size				
2888	Ø 14 (cm 14 x 12,5 h)	L 1,1	20		03 M9 G9 62 L4
2889	Ø 16 (cm 16 x 14,0 h)	L 1,7	20		03 M9 G9 62 L4
2890	Ø 18 (cm 18 x 16,0 h)	L 2,5	20		03 M9 G9 62 L4
2878	Ø 20 (cm 20 x 18,0 h)	L 3,4	10		03 M9 G9 62 86 L4 L2 01
2842	Ø 25 (cm 25 x 22,0 h)	L 6,7	5		03 M9 G9 62 86 L4 L2 01
2843	Ø 30 (cm 30 x 27,0 h)	L 11,5	5		03 M9 G9 62 86 L4 L2 01

# mitu pac

good for plants



pp



vaso con fori  
pot with holes



sottovaso abbinato  
fitting saucer



display solutions



espositore  
display



3057 total expe  
(cm 63 x 123 x 210 h)



2774 mitu  
(cm 63 x 46 x 160 h)



120  
121







medea | sottovaso • saucer

art.	size			
1471	Ø 12	(cm 12,8 x 2,1 h)	5	03 M9 G9 62 L4
1472	Ø 14	(cm 14,3 x 2,4 h)	5	03 M9 G9 62 L4
1473	Ø 16	(cm 15,9 x 2,6 h)	5	03 M9 G9 62 L4
1474	Ø 18	(cm 17,9 x 2,9 h)	5	03 M9 G9 62 86 L4 L2 01*
1476	Ø 22	(cm 22,0 x 3,6 h)	5	03 M9 G9 62 86 L4 L2 01*
1478	Ø 26	(cm 26,0 x 3,9 h)	5	03 M9 G9 62 86 L4 L2 01*

\* il minimo d'ordine per il colore 01 è 25 pcs •  
minimum order quantity for color 01 is 25 pcs



mitu pac | vaso con fori • pot with holes

art.	size				
2844	Ø 35 (cm 35 x 31 h)	L 18,5	5		
2854	Ø 40 (cm 40 x 36 h)	L 28,0	5		
2898	Ø 50 (cm 50 x 45 h)	L 55,0	2		
2879	Ø 60 (cm 60 x 53 h)	L 96,0	2		
2909	Ø 80 (cm 80 x 71 h)	L 228,0	1		
2983	Ø 100 (cm 99 x 88 h)	L 436,0	1		

# mitu pac

good for plants



pp



vaso con fori  
pot with holes



sottovaso abbinato  
fitting saucer



display solutions



espositore  
display



3057 total expe  
(cm 63 x 123 x 210 h)



122  
123

medea | sottovaso • saucer



art.	size			
1480	Ø 30 (cm 30 x 4,4 h)			03 M9 G9 62 86 L4 L2 01*
1482	Ø 36 (cm 36 x 5,0 h)			03 M9 G9 62 86 L4 L2 01*
1484	Ø 44 (cm 44 x 5,8 h)			03 M9 G9 62 86 L4 L2
1486	Ø 52 (cm 52 x 6,7 h)			03 M9 G9 62 86 L4 L2
1488	Ø 64 (cm 64 x 7,0 h)			03 M9 G9 62 86 L4 L2
1960	Ø 82 (cm 82 x 8,7 h)			03 M9 G9 62 86 L2

\* il minimo d'ordine per il colore 01 è 25 pcs •  
minimum order quantity for color 01 is 25 pcs

grande  
dimensione  
large



mitu | vaso • pot

art.	size				
2412	Ø 8	(cm 8,6 x 7,7 h)	L 0,26	24	L2
2398	Ø 10	(cm 10,0 x 8,9 h)	L 0,40	24	03 86 L2
2395	Ø 12	(cm 12,0 x 11,0 h)	L 0,70	24	03 86 L2
2396	Ø 14	(cm 14,0 x 12,5 h)	L 1,10	24	03 86 L2
2372	Ø 16	(cm 16,0 x 14,0 h)	L 1,70	24	03 86 L2
2399	Ø 18	(cm 18,0 x 16,0 h)	L 2,50	24	03 86 L2



# mitu

good for plants



PP



coprivaso  
cachepot

display solutions











espositore  
display



2774 mitu  
(cm 63 x 46 x 160 h)



mitu vision | vaso neutro trasparente • transparent pot

art.	size				
2400	Ø 8 (cm 8,6 x 7,7 h)	L 0,26	24		
2401	Ø 10 (cm 10,0 x 8,9 h)	L 0,40	24		
2402	Ø 12 (cm 12,0 x 11,0 h)	L 0,70	24		
2403	Ø 14 (cm 14,0 x 12,5 h)	L 1,10	24		
2404	Ø 16 (cm 16,0 x 14,0 h)	L 1,70	24		
2405	Ø 18 (cm 18,0 x 16,0 h)	L 2,50	24		



# mitu

---

## vision

good for **plants**



pc



coprivaso  
cachepot

easy for **sales**



impilabile  
stackable

126  
127

Realizzati in policarbonato, garantiscono la perfetta trasparenza del vetro pur essendo infrangibili.

Being made from polycarbonate, they ensure perfect glass transparency despite while also being unbreakable.

**ideale per  
orchidee**

ideal for  
orchids





mitu | ciotola con fori • plant bowl with holes

art.	size				
2 916	Ø 20 (cm 20 x 11,0 h)	L 2,3	12		
2 917	Ø 25 (cm 25 x 12,5 h)	L 4,4	12		
2 918	Ø 30 (cm 30 x 14,0 h)	L 7,4	12		

# mitu

good for plants



pp

vaso con fori  
pot with holes



sottovaso abbinato  
fitting saucer



display solutions



espositore  
display



2774 mitu  
(cm 63 x 46 x 160 h)





128  
129

mitu | sottovaso • saucer

art.	size			
2919	Ø 18 (cm 18,0 x 2,0 h)	24	03 M9 G9 86 L4 N2 42 44 L2	
2920	Ø 23 (cm 23,0 x 2,4 h)	24	03 M9 G9 86 L4 N2 42 44 L2	
2921	Ø 28 (cm 27,5 x 2,7 h)	24	03 M9 G9 86 L4 N2 42 44 L2	



mitu | ciotola • plant bowl

art.	size				
3144	Ø 20 (cm 20 x 11,0 h)	L 2,3	12	<input type="checkbox"/> 03 <input type="checkbox"/> M9 <input type="checkbox"/> G9 <input type="checkbox"/> L4	
3145	Ø 25 (cm 25 x 12,5 h)	L 4,4	12	<input type="checkbox"/> 03 <input type="checkbox"/> M9 <input type="checkbox"/> G9 <input type="checkbox"/> L4	
3146	Ø 30 (cm 30 x 14,0 h)	L 7,4	12	<input type="checkbox"/> 03 <input type="checkbox"/> M9 <input type="checkbox"/> G9 <input type="checkbox"/> L4	

# mitu

good for plants



pp



display solutions



espositore  
display





2774 mitu  
(cm 63 x 46 x 160 h)





clivo | vaso con fori • pot with holes

art.	size				
2880	Ø 14 (cm 14 x 14 h)	L 1,4	24	98 N1 86 L4	
2881	Ø 16 (cm 16 x 16 h)	L 2,2	24	98 N1 86 L4	
2882	Ø 18 (cm 18 x 18 h)	L 3,1	24	98	

# clivo

good for plants



pp



vaso con fori  
pot with holes



sottovaso abbinato  
fitting saucer



display solutions



espositore  
display



2774 mitu  
(cm 63 x 46 x 160 h)





3055 tray  
(cm 55 x 37 x 54 h)



132  
133

mitu | sottovaso • saucer

art.	size			
2768	Ø 12	(cm 12,5 x 2,4 h)	24	98 N1 86 L4
2769	Ø 14	(cm 14,0 x 2,8 h)	24	98 N1 86 L4
2770	Ø 16	(cm 16,0 x 3,0 h)	24	98



clivo | vaso • pot

art.	size				
2575	Ø 14 (cm 14 x 14 h)	L 1,4	24	03 M9 G9 N1 86 44 R0 69	
2576	Ø 16 (cm 16 x 16 h)	L 2,2	24	03 M9 G9 N1 86 44 R0 69	
2577	Ø 18 (cm 18 x 18 h)	L 3,1	24	03 M9 G9 N1 86 44 R0 69	

# clivo

good for plants



pp



coprivaso  
cachepot

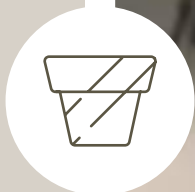

display solutions



espositore  
display



2774 mitu  
(cm 63 x 46 x 160 h)



3055 tray  
(cm 55 x 37 x 54 h)







clivo orchidea | vaso • pot

art.	size				
2610	Ø 12,5	(cm 12,5 x 15 h)	L 1,1	24	03 86 44 L2

# clivo orchidea

good for plants



pp



coprivaso  
cachepot

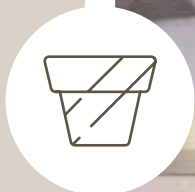

display solutions



espositore  
display



3055 tray  
(cm 55 x 37 x 54 h)



136  
137



ideale per  
orchidee

ideal for  
orchids

PASSIONATE BY NATURE



clivo | cassetta • plant box

art.	size				
2771	cm 28	(cm 28,5x13x12h)	L 3	12	      

# clivo

good for plants



pp



coprivaso  
cachepot



display solutions



espositore  
display



2774 mitu  
(cm 63 x 46 x 160 h)





liken | vaso • pot

art.	size				
3028	Ø 27 (cm 27 x 36 h)	L 13	5	<span>03</span> <span>M9</span> <span>G9</span> <span>62</span> <span>86</span> <span>L4</span> <span>L2</span>	
3029	Ø 34 (cm 34 x 46 h)	L 26	5	<span>03</span> <span>M9</span> <span>G9</span> <span>62</span> <span>86</span> <span>L4</span> <span>L2</span>	
3030	Ø 41 (cm 41 x 55 h)	L 45	5	<span>03</span> <span>M9</span> <span>G9</span> <span>62</span> <span>86</span> <span>L4</span> <span>L2</span>	



# liken

good for **plants**



pp



coprivaso  
cachepot





easy for **sales**



impilabile  
stackable



miu | vaso • pot

art.	size				
2839	Ø 7 (cm 7 x 6,4 h)	L 0,20	12		
2840	Ø 9 (cm 9 x 8,2 h)	L 0,45	12		
2841	Ø 11 (cm 11 x 10,0 h)	L 0,85	12		
2908	Ø 13 (cm 13 x 12,0 h)	L 1,40	12		

# miu

good for plants



pp



coprivaso  
cachepot



display solutions



espositore  
display



3055 tray  
(cm 55 x 37 x 54 h)



142  
143

ideale per  
piante grasse  
ideal for  
succulent plants





mey | coprivaso • cachepot

art.	size								
3002	Ø 20	(cm 20 x 18 h)	L 4,3	6					
3003	Ø 25	(cm 25 x 23 h)	L 8,6	6					

# mey

good for **plants**



pp



coprivaso  
cachepot



easy for **sales**



impilabile  
stackable



144  
145

mey | coprivaso con ruote • cachepot with rollers

art.	size				
3004	Ø 30 (cm 30 x 29 h)	L 14,8	6	03 M9 07 86 L2 69	
3005	Ø 35 (cm 35 x 34 h)	L 23,0	6	03 M9 07 86 L2 69	
3006	Ø 40 (cm 40 x 39 h)	L 35,0	6	03 M9 07 86 L2 69	

con ruote  
nascoste

with hidden  
rollers



synue | vaso • pot

art.	size				
2551	Ø 14 (cm 14 x 12,5 h)	L 1,4	24	03 86 44 NO 69	
2552	Ø 16 (cm 16 x 14,5 h)	L 2,0	24	03 86 44 NO 69	
2553	Ø 18 (cm 18 x 16,0 h)	L 2,9	24	03 86 44 NO 69	



# synue

good for plants



pp



coprivaso  
cachepot

display solutions



espositore  
display





2774 mitu  
(cm 63 x 46 x 160 h)



3055 tray  
(cm 55 x 37 x 54 h)



quadria | vaso • pot

art.	size				
2554	<b>cm 14</b>	(cm 14 x 14 x 12,5 h)	L 1,7	24	03 86 44
2555	<b>cm 16</b>	(cm 16 x 16 x 14,5 h)	L 2,5	24	03 86 44
2556	<b>cm 18</b>	(cm 18 x 18 x 16,0 h)	L 3,6	24	03 86 44



# quadria

good for plants



pp



coprivaso  
cachepot

display solutions





espositore  
display



2774 mitu  
(cm 63 x 46 x 160 h)



cubik | vaso • pot

art.	size				
2544	<b>cm 11</b>	(cm 11 x 11 x 11 h)	L 1,1	8	03
2545	<b>cm 16</b>	(cm 16 x 16 x 16 h)	L 3,5	8	03
2546	<b>cm 21</b>	(cm 21 x 21 x 21 h)	L 8,3	4	03



# cubik

good for plants



abs



coprivaso  
cachepot









150  
151

robusto  
sturdy





**cubik vision | vaso neutro trasparente • transparent pot**

art.	size				
2595	<b>cm 11</b>	(cm 11 x 11 x 11 h)	L 1,1	8	
2596	<b>cm 16</b>	(cm 16 x 16 x 16 h)	L 3,5	8	
2597	<b>cm 21</b>	(cm 21 x 21 x 21 h)	L 8,3	4	



# cubik

---

## vision

good for plants



pc



coprivaso  
cachepot

152  
153







Realizzati in policarbonato, garantiscono la perfetta trasparenza del vetro pur essendo infrangibili.

Being made from polycarbonate, they ensure perfect glass transparency despite while also being unbreakable.

**infrangibile**  
unbreakable



twister | ciotola • plant bowl

art.	size				
*2431	Ø 17	(cm 17 x 8,9 h)	L 1,4	24	
*2432	Ø 21	(cm 21 x 11,0 h)	L 2,7	24	
*2455	Ø 25	(cm 25 x 13,0 h)	L 4,7	24	

\* per quantitativi minimi • for minimum orders

# twister

good for **plants**



pp



coprivaso  
cachepot



easy for **sales**





impilabile  
stackable





vertigo | vaso • pot

art.	size				
*2434	Ø 12 (cm 12 x 9,0 h)	L 0,6	24	86 44 D3	
*2435	Ø 14 (cm 14 x 10,5 h)	L 1,0	24	86 44 D3	
*2436	Ø 16 (cm 16 x 12,0 h)	L 1,5	24	86 44 D3	
*2437	Ø 18 (cm 18 x 13,5 h)	L 2,2	24	86 44 D3	
*2438	Ø 20 (cm 20 x 15,0 h)	L 3,0	24	86 44 D3	

\* per quantitativi minimi • for minimum orders

# vertigo

good for plants



pp



coprivaso  
cachepot



easy for sales



impilabile  
stackable





mitu tre | ciotola • plant bowl

art.	size				
*2410	cm 17	(cm 18 x 17 x 11 h)	L 1,7	24	

\* per quantitativi minimi • for minimum orders

# mitu tre

good for plants



pp



coprivaso  
cachepot



display solutions



espositore  
display



2774 mitu  
(cm 63 x 46 x 160 h)









# style



100%  
Recyclable



Lightweight



Antishock



U.V.  
Resistant









Temperature  
Resistant



kube | cassetta • plant box

art.	size						
2601	cm 80	(cm 80 x 30 x 30 h)	L 32	A4327	2 x A4629	1	     
2548	cm 100	(cm 100 x 40 x 40 h)	L 73	A4278	2 x A4629	1	     

kube | cassetta con ruote • plant box with castors

art.	size					
2753	cm 80	(cm 80 x 30 x 31 h)	L 32	A4327	1	     
2590	cm 100	(cm 100 x 40 x 41 h)	L 73	A4278	1	     



# kuba

good for plants



lلدpe



kit riserva d'acqua  
water reserve kit



easy for sales



rifinito a mano  
hand-finished



cassetta vaso abbinati  
matching plant box pot



kit fissaggio a terra  
ground fixing kit

display solutions



cover pallet

162  
163

## kuba | vaso • pot

art.	size						
2538	cm 30	(cm 30 x 30 x 30 h)	L 9	A4255	A4629	1	(C2) G9 S3 S4 87 E5
2514	cm 40	(cm 40 x 40 x 40 h)	L 22	A4241	A4629	1	(C2) G9 S3 S4 87 86 43 E5 C1
2515	cm 50	(cm 50 x 50 x 50 h)	L 45	A4242	A4629	1	(C2) G9 S3 S4 87 86 43 E5 C1





## kuba | vaso con ruote • pot with castors

art.	size					
2587	cm 30	(cm 30 x 30 x 31 h)	L 9	A4255	1	(C2) G9 S3 S4 87 E5
2588	cm 40	(cm 40 x 40 x 41 h)	L 22	A4241	1	(C2) G9 S3 S4 87 86 43 E5 C1
2589	cm 50	(cm 50 x 50 x 51 h)	L 45	A4242	1	(C2) G9 S3 S4 87 86 43 E5 C1

anche con  
ruote nascoste  
also with  
hidden castors



kube gloss | vaso • pot

art.	size						
2583	<b>cm 30</b>	(cm 30 x 30 x 30 h)	L 9	A4255	A4629	1	 
2584	<b>cm 40</b>	(cm 40 x 40 x 40 h)	L 22	A4241	A4629	1	 
2585	<b>cm 50</b>	(cm 50 x 50 x 50 h)	L 45	A4242	A4629	1	 



# kube

## gloss

good for plants



100%  
lلدpe



kit riserva d'acqua  
water reserve kit

easy for sales















rifinito a mano  
hand-finished



kit fissaggio a terra  
ground fixing kit

164  
165









kube gloss | vaso con ruote • pot with castors

art.	size					 
2592	cm 30	(cm 30 x 30 x 31 h)	L 9	A4255	1	 
2593	cm 40	(cm 40 x 40 x 41 h)	L 22	A4241	1	 
2594	cm 50	(cm 50 x 50 x 51 h)	L 45	A4242	1	 

anche con  
ruote nascoste  
also with  
hidden castors



kube mini | cassetta • plant box

art.	size						
2828	<b>cm 50</b>	(cm 50 x 18 x 18 h)	L 9,0	A4415	A4629	1	 
2776	<b>cm 60</b>	(cm 60 x 20 x 20 h)	L 11,5		A4629	1	 

# kube mini

good for plants



lIdpe



easy for sales



rifinito a mano  
hand-finished



kit fissaggio a terra  
ground fixing kit



166  
167

kube mini | vaso • pot

art.	size					
2827	<b>cm 18</b>	(cm 18 x 18 x 18 h)	L 2,7	A4629	1	 
2634	<b>cm 20</b>	(cm 20 x 20 x 20 h)	L 2,7	A4629	1	 





kube mini | cassetta con riserva d'acqua • plant box with water reserve

art.	size						
2852	cm 50	(cm 50 x 18 x 18 h)	L 9,0	L 3	A4415	1	©2 G9

# kube mini

good for plants



lلدpe



easy for sales



rifinito a mano  
hand-finished

168  
169

kube mini | vaso con riserva d'acqua • pot with water reserve

art.	size					
2853	cm 18	(cm 18 x 18 x 18 h)	L 2,7	L 1	1	

con riserva  
d'acqua  
with water  
reserve



**kube mini** | cassetta • plant box with mini led light kit (indoor)

art.	size		
2791	cm 60	(cm 60 x 20 x 20 h)	1 

# kube mini

## light

material



HDPE



easy for sales



rifinito a mano  
hand-finished



kit luce montato  
installed light kit



170  
171

kube mini | vaso • pot with mini led light kit (indoor)

















art.	size			
2783	cm 20	(cm 20 x 20 x 20 h)	1	(98)



**kube high | cassetta alta • high plant box**

art.	size						
2602	cm 80	(cm 80 x 30 x 70 h)	L 32,0	A4327	2 x A4629	1	     
2586	cm 100	(cm 100 x 40 x 70 h)	L 77,5	A4278	2 x A4629	1	     

**kube high | cassetta alta con ruote • high plant box with castors**

art.	size					
2754	cm 80	(cm 80 x 30 x 71 h)	L 32,0	A4327	1	     
2591	cm 100	(cm 100 x 40 x 71 h)	L 77,5	A4278	1	     

# kube high

## good for plants



lIdpe



kit riserva d'acqua  
water reserve kit



## easy for sales



rifinito a mano  
hand-finished



cassetta vaso abbinati  
matching plant box pot



kit fissaggio a terra  
ground fixing kit



kit posacenere  
ashtray kit

## display solutions



cover pallet

172  
173

### kube high | vaso alto • high pot

art.	size							
2611	cm 30	(cm 30 x 30 x 70 h)	L 9	A4255	A4629	A4350	1	
2612	cm 40	(cm 40 x 40 x 70 h)	L 23	A4241	A4629		1	

### kube high | vaso alto con ruote • high pot with castors

art.	size						
2733	cm 30	(cm 30 x 30 x 71 h)	L 9	A4255	1		
2734	cm 40	(cm 40 x 40 x 71 h)	L 23	A4241	1		

anche con  
ruote nascoste  
also with  
hidden castors



kube high special colors | cassetta alta • high plant box

art.	size						
*2602	cm 80	(cm 80 x 30 x 70 h)	L 32	A4327	2 x A4629	1	  

\* per quantitativi minimi • for minimum orders



# kube high

## special colors

good for plants



100%  
lلدpe



kit riserva d'acqua  
water reserve kit

easy for sales



rifinito a mano  
hand-finished



cassetta vaso abbinati  
matching plant box pot



kit fissaggio a terra  
ground fixing kit



kit posacenere  
ashtray kit

174  
175

kube high special colors | vaso alto • high pot



art.	size							
*2611	cm 30	(cm 30 x 30 x 70 h)	L 9	A4255	A4629	A4350	1	

\* per quantitativi minimi • for minimum orders











**kube high | cass. alta • high plant box light (indoor)**

art.	size				
2745	cm 80	(cm 80 x 30 x 70 h)	2 x A4629	1	98
2701	cm 100	(cm 100 x 40 x 70 h)	2 x A4629	1	98



**kube high | cass. alta • high plant box rgb E27 light (indoor)**

art.	size				
3109	cm 80	(cm 80 x 30 x 70 h)	2 x A4629	1	98
3110	cm 100	(cm 100 x 40 x 70 h)	2 x A4629	1	98

**kube high | cass. alta • high plant box light (outdoor)**

art.	size				
*2746	cm 80	(cm 80 x 30 x 70 h)	2 x A4629	1	98
*2702	cm 100	(cm 100 x 40 x 70 h)	2 x A4629	1	98

**kube high | cass. alta • high plant box rgb E27 light (outdoor)**

art.	size				
*3111	cm 80	(cm 80 x 30 x 70 h)	2 x A4629	1	98
*3112	cm 100	(cm 100 x 40 x 70 h)	2 x A4629	1	98

\* con canaletta di scolo • with drainage tube

il kit luce RGB E27 è dotato di telecomando •  
RGB E27 light kit with remote control

# kube high

## light

material



llDpe



easy for sales



rifinito a mano  
hand-finished



cassetta vaso abbinati  
matching plant box pot



kit fissaggio a terra  
ground fixing kit



kit luce montato  
installed light kit



176  
177

**kube high | vaso alto • high pot light (indoor)**

art.	size				
2737	cm 30	(cm 30 x 30 x 70 h)	A4629	1	98
2741	cm 40	(cm 40 x 40 x 70 h)	A4629	1	98

**kube high | vaso alto • high pot rgb E27 light (indoor)**

art.	size				
3116	cm 30	(cm 30 x 30 x 70 h)	A4629	1	98
3117	cm 40	(cm 40 x 40 x 70 h)	A4629	1	98

**kube high | vaso alto • high pot light (outdoor)**

art.	size				
2738	cm 30	(cm 30 x 30 x 70 h)	A4629	1	98
*2742	cm 40	(cm 40 x 40 x 70 h)	A4629	1	98

**kube high | vaso alto • high pot rgb E27 light (outdoor)**

art.	size				
3118	cm 30	(cm 30 x 30 x 70 h)	A4629	1	98
*3119	cm 40	(cm 40 x 40 x 70 h)	A4629	1	98

\* con canaletta di scolo • with drainage tube

il kit luce RGB E27 è dotato di telecomando •  
RGB E27 light kit with remote control



kube high slim | cassetta alta • high plant box

art.	size						
2777	cm 80	(cm 80 x 25 x 70 h)	L 32	A4327	2 x A4629	1	    



# kube high slim

## good for plants



lIdpe



kit riserva d'acqua  
water reserve kit



## easy for sales



rifinito a mano  
hand-finished



cassetta vaso abbinati  
matching plant box pot



kit fissaggio a terra  
ground fixing kit

## display solutions



cover pallet

178  
179

### kube high slim | vaso alto • high pot

art.	size						
2788	cm 25	(cm 25 x 25 x 70 h)	L 8,8	A4255	A4629	1	



**kube high slim | cass. alta • high plant box light (indoor)**

art.	size				
2792	cm 80	(cm 80 x 25 x 70 h)	2 x A4629	1	98

**kube high slim | cass. alta • high plant box rgb E27 light (indoor)**

art.	size				
3113	cm 80	(cm 80 x 25 x 70 h)	2 x A4629	1	98

**kube high slim | cass. alta • high plant box light (outdoor)**

art.	size				
*2793	cm 80	(cm 80 x 25 x 70 h)	2 x A4629	1	98

**kube high slim | cass. alta • high plant box rgb E27 light (outdoor)**

art.	size				
*3114	cm 80	(cm 80 x 25 x 70 h)	2 x A4629	1	98

\* con canaletta di scolo • with drainage tube

il kit luce RGB E27 è dotato di telecomando •  
RGB E27 light kit with remote control

# kube high slim

## light

material



lldpe

easy for sales



rifinito a mano  
hand-finished



cassetta vaso abbinati  
matching plant box pot



kit fissaggio a terra  
ground fixing kit



kit luce montato  
installed light kit

180  
181

**kube high slim | vaso alto • high pot (indoor)**

art.	size				
2796	cm 25	(cm 25 x 25 x 70 h)	A4629	1	98

**kube high slim | vaso alto • high pot rgb E27 light (indoor)**

art.	size				
3120	cm 25	(cm 25 x 25 x 70 h)	A4629	1	98

**kube high slim | vaso alto • high pot light (outdoor)**

art.	size				
2797	cm 25	(cm 25 x 25 x 70 h)	A4629	1	98





**kube high slim | vaso alto • high pot rgb E27 light (outdoor)**

art.	size				
3121	cm 25	(cm 25 x 25 x 70 h)	A4629	1	98

il kit luce RGB E27 è dotato di telecomando •  
RGB E27 light kit with remote control



kube high slim | modulo • module

art.	size				
*2790	cm 25	(cm 25 x 25 x 70 h)	1 x A4629	1	
*2789	cm 80	(cm 80 x 25 x 70 h)	2 x A4629	1	

\* per quantitativi minimi • for minimum orders



# kube high slim

good for plants



Ildpe

easy for sales



rifinito a mano  
hand-finished



kit fissaggio a terra  
ground fixing kit

display solutions



cover pallet





kube tower | cassetta alta • high plant box

art.	size						
2825	cm 70	(cm 70 x 30 x 90 h)	L 29	A4327	2 x A4629	1	©2 G9 87 E5



# kube tower

## good for plants



lIdpe



kit riserva d'acqua  
water reserve kit



## easy for sales



rifinito a mano  
hand-finished



cassetta vaso abbinati  
matching plant box pot



kit fissaggio a terra  
ground fixing kit



kit posacenere  
ashtray kit

## display solutions



cover pallet









184  
185

### kube tower | vaso alto • high pot

art.	size							
2826	cm 30	(cm 30 x 30 x 90 h)	L 10	A4255	A4629	A4350	1	(C2) (G9) (87) (E5)



kube tower special colors | cassetta alta • high plant box

art.	size						
*2825	cm 70	(cm 70 x 30 x 90 h)	L 29	A4327	2 x A4629	1	  

\* per quantitativi minimi • for minimum orders



# kube tower

## special colors

good for plants



100%  
lIdpe



kit riserva d'acqua  
water reserve kit

easy for sales



rifinito a mano  
hand-finished



cassetta vaso abbinati  
matching plant box pot









kit fissaggio a terra  
ground fixing kit



kit posacenere  
ashtray kit

186  
187

kube tower special colors | vaso alto • high pot

art.	size							
*2826	cm 30	(cm 30 x 30 x 90 h)	L 10	A4255	A4629	A4350	1	  

\* per quantitativi minimi • for minimum orders



**kube tower | cass. alta • high plant box light (indoor)**

art.	size				
2835	cm 70	(cm 70 x 30 x 90 h)	2 x A4629	1	98

**kube tower | cass. alta • high plant box rgb E27 light (indoor)**

art.	size				
3085	cm 70	(cm 70 x 30 x 90 h)	2 x A4629	1	98

**kube tower | cass. alta • high plant box light (outdoor)**

art.	size				
*2836	cm 70	(cm 70 x 30 x 90 h)	2 x A4629	1	98

**kube tower | cass. alta • high plant box rgb E27 light (outdoor)**

art.	size				
*3115	cm 70	(cm 70 x 30 x 90 h)	2 x A4629	1	98

\* con canaletta di scolo • with drainage tube

il kit luce RGB E27 è dotato di telecomando •  
RGB E27 light kit with remote control



# kube tower

## light

material



lIdpe

easy for sales



rifinito a mano  
hand-finished



cassetta vaso abbinati  
matching plant box pot



kit fissaggio a terra  
ground fixing kit



kit luce montato  
installed light kit

188  
189

**kube tower** | vaso alto • high pot light (indoor)

art.	size			
2831	cm 30	(cm 30 x 30 x 90 h)	A4629	1

**kube tower** | vaso alto • high pot rgb E27 light (indoor)

art.	size			
3122	cm 30	(cm 30 x 30 x 90 h)	A4629	1

**kube tower** | vaso alto • high pot light (outdoor)

art.	size			
2832	cm 30	(cm 30 x 30 x 90 h)	A4629	1

**kube tower** | vaso alto • high pot rgb E27 light (outdoor)

art.	size			
3123	cm 30	(cm 30 x 30 x 90 h)	A4629	1

il kit luce RGB E27 è dotato di telecomando •  
RGB E27 light kit with remote control



kube | panca • bench

art.	size				
2549	cm 100	(cm 100 x 40 x 40 h)	2 x A4629	1	©2 87 E5

# kube

material



lIdpe

easy for sales



rifinito a mano  
hand-finished



kit fissaggio a terra  
ground fixing kit



190  
191

kube | sgabello • stool

art.	size				
2532	<b>cm 40</b>	(cm 40 x 40 x 40 h)	A4629	1	
*2533	<b>cm 50</b>	(cm 50 x 50 x 50 h)	A4629	1	

\* per quantitativi minimi • for minimum orders





kube special colors | panca • bench

art.	size				
*2549	cm 100	(cm 100 x 40 x 40 h)	2 x A4629	1	  

\* per quantitativi minimi • for minimum orders



# kube

## special colors

good for plants



11dpe

easy for sales



rifinito a mano  
hand-finished



kit fissaggio a terra  
ground fixing kit

192  
193

kube special colors | sgabello • stool

art.	size				
*2532	cm 40	(cm 40 x 40 x 40 h)	A4629	1	  

\* per quantitativi minimi • for minimum orders



**kuba | panca • bench light (indoor)**

art.	size				
2755	cm 100	(cm 100 x 40 x 40 h)	2 x A4629	1	98

**kuba | panca • bench rgb E27 light (indoor)**

art.	size				
3103	cm 100	(cm 100 x 40 x 40 h)	2 x A4629	1	98

**kuba | panca • bench light (outdoor)**

art.	size				
2756	cm 100	(cm 100 x 40 x 40 h)	2 x A4629	1	98

**kuba | panca • bench rgb E27 light (outdoor)**

art.	size				
3104	cm 100	(cm 100 x 40 x 40 h)	2 x A4629	1	98

il kit luce RGB E27 è dotato di telecomando •  
RGB E27 light kit with remote control

# kube

## light

material



HDPE



easy for sales



rifinito a mano  
hand-finished



kit fissaggio a terra  
ground fixing kit



kit luce montato  
installed light kit



194  
195

### kube | sgabello • stool light (indoor)

art.	size				
2705	cm 40	(cm 40 x 40 x 40 h)	A4629	1	98
2708	cm 50	(cm 50 x 50 x 50 h)	A4629	1	98

### kube | sgabello • stool rgb E27 light (indoor)

art.	size				
3105	cm 40	(cm 40 x 40 x 40 h)	A4629	1	98
3107	cm 50	(cm 50 x 50 x 50 h)	A4629	1	98

### kube | sgabello • stool light (outdoor)

art.	size				
2706	cm 40	(cm 40 x 40 x 40 h)	A4629	1	98
2709	cm 50	(cm 50 x 50 x 50 h)	A4629	1	98

### kube | sgabello • stool rgb E27 light (outdoor)

art.	size				
3106	cm 40	(cm 40 x 40 x 40 h)	A4629	1	98
3108	cm 50	(cm 50 x 50 x 50 h)	A4629	1	98

il kit luce RGB E27 è dotato di telecomando •  
RGB E27 light kit with remote control



**kube mini** | cubo • cube with mini led light kit (indoor)

art.	size		
2784	cm 20	(cm 20 x 20 x 20 h)	1 



# kube mini

---

## light

material



lldpe

easy for **sales**







rifinito a mano  
hand-finished



kit luce montato  
installed light kit



ikon | vaso • pot

art.	size					
2603	Ø 40 (cm 40 x 36 h)	L 23				1 (C2 G9 87)
2604	Ø 50 (cm 50 x 44 h)	L 47				1 (C2 M9 G9 S3 S4 87 E5)
2605	Ø 60 (cm 60 x 53 h)	L 82	1 x A4631			1 (C2 M9 G9 S3 S4 87 D7 E5)
2896	Ø 70 (cm 70 x 62 h)	L 130	1 x A4631			1 (C2 M9 G9 S3 S4 87 D7 E5)
2541	Ø 80 (cm 80 x 71 h)	L 202	1 x A4631			1 (C2 M9 G9 S3 S4 87 86 D7 E5)
2542	Ø 100 (cm 100 x 89 h)	L 398	2 x A4631			1 (C2 M9 G9 S3 S4 87 86 D7 E5)
2543	Ø 120 (cm 120 x 107 h)	L 680	2 x A4631			1 (C2 M9 G9 87 86 D7 E5)
2786	Ø 140 (cm 140 x 125 h)	L1066				1 (C2 G9 87 D7 E5)
2787	Ø 160 (cm 160 x 143 h)	L1594				1 (C2 G9 87 D7 E5)



# ikon

## good for plants



lhdpe



sottovaso abbinato  
fitting saucer



## easy for sales



rifinito a mano  
hand-finished



kit fissaggio a terra  
ground fixing kit

## display solutions



cover pallet

198  
199

### ikon | sottovaso • saucer

art.	size			
2607	Ø 50	(cm 36,0 x 3,5 h)	1	C2 M9 G9 S3 S4 87 E5
2608	Ø 60	(cm 42,5 x 4,0 h)	1	C2 M9 G9 S3 S4 87 D7 E5
2897	Ø 70	(cm 50,5 x 4,5 h)	1	C2 M9 G9 S3 S4 87 D7 E5
2598	Ø 80	(cm 56,0 x 5,0 h)	1	C2 M9 G9 S3 S4 87 86 D7 E5
2599	Ø 100	(cm 71,0 x 6,0h)	1	C2 M9 G9 S3 S4 87 86 D7 E5
2600	Ø 120	(cm 85,0 x 7,0 h)	1	C2 M9 G9 87 86 D7 E5
2814	Ø 140	(cm 99,0 x 8,5 h)	1	C2 G9 87 D7 E5
2815	Ø 160	(cm 113,0 x 9,5 h)	1	C2 G9 87 D7 E5

i sottovasi possono essere ordinati solo contestualmente ai vasi cui sono abbinati e in quantità uguale, inferiore o secondo la disponibilità • these saucers may only be ordered at the same time as the pots they are matched to, and in the same or fewer quantities, depending on availability





ikon | vaso con fori • pot with holes

art.	size				
2996	Ø 200 (cm 200 x 178 h)	L 3139	1		Ⓢ Ⓒ2 Ⓓ9 Ⓔ7 Ⓕ7 Ⓖ5

ikon | sottovaso • saucer

art.	size			
3008	Ø 200 (cm 141 x 12 h)	1		Ⓢ Ⓒ2 Ⓓ9 Ⓔ7 Ⓕ7 Ⓖ5

i sottovasi possono essere ordinati solo contestualmente ai vasi cui sono abbinati e in quantità uguale, inferiore o secondo la disponibilità • these saucers may only be ordered at the same time as the pots they are matched to, and in the same or fewer quantities, depending on availability



# ikon

good for plants



lIdpe



sottovaso abbinato  
fitting saucer

easy for sales



rifinito a mano  
hand-finished

200  
201





ikon | vaso con fori chiuso sopra • pot with holes closed on top

art.	size				
3012	Ø 200 (cm200x178h)		L 767	1	    

grande  
dimensione  
large



ikon laccato | vaso laccato • lacquered pot

art.	size					
*L2603	Ø 40 (cm 40 x 36 h)	L 23			1	07 07
*L2604	Ø 50 (cm 50 x 44 h)	L 47			1	07 07
*L2605	Ø 60 (cm 60 x 53 h)	L 82	1 x A4631		1	07 07
*L2896	Ø 70 (cm 70 x 62 h)	L 130	1 x A4631		1	07 07
*L2541	Ø 80 (cm 80 x 71 h)	L 202	1 x A4631		1	07 07
*L2542	Ø 100 (cm 100 x 89 h)	L 398	2 x A4631		1	07 07
*L2543	Ø 120 (cm 120 x 107 h)	L 680	2 x A4631		1	07 07

\* per quantitativi minimi • for minimum orders



# ikon

laccato • lacquered

good for plants



lldpe

easy for sales



rifinito a mano  
hand-finished



kit fissaggio a terra  
ground fixing kit



202  
203

Sottoposti a un elaborato processo di laccatura,  
si vestono di una preziosa finitura lucida.



Having received an elaborate lacquering process,  
they have a precious gloss finish



ikon | vaso • pot light (indoor)

art.	size				
2721	Ø 40 (cm 40 x 36 h)			1	98
2725	Ø 50 (cm 50 x 44 h)			1	98
2729	Ø 60 (cm 60 x 53 h)	1 x A4631		1	98
2899	Ø 70 (cm 70 x 62 h)	1 x A4631		1	98
2641	Ø 80 (cm 80 x 71 h)	1 x A4631		1	98
2653	Ø 100 (cm 100 x 89 h)	2 x A4631		1	98
2657	Ø 120 (cm 120 x 107 h)	2 x A4631		1	98
2806	Ø 140 (cm 140 x 125 h)			1	98
2810	Ø 160 (cm 160 x 143 h)			1	98

ikon | vaso • pot light (outdoor)

art.	size				
2722	Ø 40 (cm 40 x 36 h)			1	98
2726	Ø 50 (cm 50 x 44 h)			1	98
2730	Ø 60 (cm 60 x 53 h)	1 x A4631		1	98
2900	Ø 70 (cm 70 x 62 h)	1 x A4631		1	98
2642	Ø 80 (cm 80 x 71 h)	1 x A4631		1	98
2654	Ø 100 (cm 100 x 89 h)	2 x A4631		1	98
2658	Ø 120 (cm 120 x 107 h)	2 x A4631		1	98
2807	Ø 140 (cm 140 x 125 h)			1	98
2811	Ø 160 (cm 160 x 143 h)			1	98

il vaso IKON in versione light non può essere allestito con terra, piante, vasi o con oggetti vari •  
the light version of the IKON pot cannot be set up with soil, plants, vases or various other objects



# ikon

## light

material



llDpe

easy for sales



rifinito a mano  
hand-finished





kit fissaggio a terra  
ground fixing kit





kit luce montato  
installed light kit

204  
205

### ikon | vaso • pot rgb E27 light (indoor)

art.	size				
3070	Ø 40 (cm 40 x 36 h)			1	98
3071	Ø 50 (cm 50 x 44 h)			1	98
3072	Ø 60 (cm 60 x 53 h)		1 x A4631	1	98
3073	Ø 70 (cm 70 x 62 h)		1 x A4631	1	98
3074	Ø 80 (cm 80 x 71 h)		1 x A4631	1	98
3075	Ø 100 (cm 100 x 89 h)		2 x A4631	1	98
3076	Ø 120 (cm 120 x 107 h)		2 x A4631	1	98
3077	Ø 140 (cm 140 x 125 h)			1	98
3078	Ø 160 (cm 160 x 143 h)			1	98

### ikon | vaso • pot rgb E27 light (outdoor)

art.	size				
3079	Ø 40 (cm 40 x 36 h)			1	98
3080	Ø 50 (cm 50 x 44 h)			1	98
3081	Ø 60 (cm 60 x 53 h)		1 x A4631	1	98
3082	Ø 70 (cm 70 x 62 h)		1 x A4631	1	98
3083	Ø 80 (cm 80 x 71 h)		1 x A4631	1	98
3084	Ø 100 (cm 100 x 89 h)		2 x A4631	1	98
3086	Ø 120 (cm 120 x 107 h)		2 x A4631	1	98
3087	Ø 140 (cm 140 x 125 h)			1	98
3088	Ø 160 (cm 160 x 143 h)			1	98

il kit luce RGB E27 è dotato di telecomando • RGB E27 light kit with remote control



**ikon 1 kit | vaso • pot light (outdoor)**

art.	size		
2999	Ø 200	(cm 200 x 178 h)	1 (98)

**ikon 1 kit | vaso • pot rgb E27 light (outdoor)**

art.	size		
3089	Ø 200	(cm 200 x 178 h)	1 (98)

il vaso IKON in versione light non può essere allestito con terra, piante, vasi o con oggetti vari •  
the light version of the IKON pot cannot be set up with soil, plants, vases or various other objects



# ikon

---

## light

material



llDpe

easy for **sales**



rifinito a mano  
hand-finished



kit luce montato  
installed light kit

206  
207

ikon 3 kit | vaso • pot light (outdoor)

art.	size			
3 015	Ø 200	(cm 200 x 178 h)	1	98

ikon 3 kit | vaso • pot rgb E27 light (outdoor)



art.	size			
3090	Ø 200	(cm 200 x 178 h)	1	98

il kit luce RGB E27 è dotato di telecomando • RGB E27 light kit with remote control





ikon mini | vaso • pot

art.	size				
2635	Ø 20	(cm 20 x 17,5 h)	L 1,7	1	©2 G9

# ikon mini

good for plants



lhdpe



easy for sales



rifinito a mano  
hand-finished



impilabile  
stackable





ikon mini | vaso • pot with mini led light kit (indoor)

art.	size		
2782	Ø 20	(cm 20 x 17,5 h)	1
			98

# ikon mini

---

## light

material



lIdpe

easy for **sales**





















**rifinito a mano**  
hand-finished



**kit luce montato**  
installed light kit



simple rot | vaso • pot

art.	size				
3063	Ø 30 (cm 30 x 26 h)	L 11	1	   	
3060	Ø 40 (cm 40 x 35 h)	L 26	1	   	
3061	Ø 50 (cm 50 x 43 h)	L 51	1	   	
3062	Ø 60 (cm 60 x 52 h)	L 87	1	   	

# simple rot

good for plants



lhdpe



easy for sales



rifinito a mano  
hand-finished



impilabile  
stackable



# etria

good for plants



lldpe

easy for sales



rifinito a mano  
hand-finished

display solutions



cover pallet



etria | vaso con doppia parete • pot with double wall

art.	size				
2453	Ø 24 (cm 24 x 20 h)	L 5	1		<span>C2</span> <span>M9</span> <span>G9</span> <span>87</span> <span>E5</span> <span>45</span> <span>69</span>
2318	Ø 34 (cm 34 x 28 h)	L 14	1		<span>C2</span> <span>M9</span> <span>G9</span> <span>87</span> <span>E5</span> <span>45</span> <span>69</span>
2319	Ø 44 (cm 44 x 36 h)	L 30	1		<span>C2</span> <span>M9</span> <span>G9</span> <span>87</span> <span>E5</span> <span>45</span> <span>69</span>
2320	Ø 54 (cm 54 x 44 h)	L 56	1		<span>C2</span> <span>M9</span> <span>G9</span> <span>87</span> <span>E5</span> <span>45</span> <span>69</span>
2447	Ø 64 (cm 64 x 52 h)	L 86	1		<span>C2</span> <span>M9</span> <span>G9</span> <span>87</span> <span>E5</span> <span>45</span> <span>69</span>
2454	Ø 74 (cm 74 x 61 h)	L 131	1		<span>C2</span> <span>M9</span> <span>G9</span> <span>87</span> <span>E5</span> <span>69</span>



# etria uno

good for plants



lldpe



easy for sales



rifinito a mano  
hand-finished

display solutions



cover pallet

214  
215





etria uno | vaso con singola parete • pot with single wall

art.	size				
2860	Ø 24 (cm 24 x 20 h)	L 6	1		(C2) (M9) (G9) (87) (N1) (N0) (E5)
2861	Ø 34 (cm 34 x 28 h)	L 18	1		(C2) (M9) (G9) (87) (N1) (N2) (N0) (E5)
2862	Ø 44 (cm 44 x 36 h)	L 39	1		(C2) (M9) (G9) (87) (N1) (N2) (N0) (E5)
2863	Ø 54 (cm 54 x 44 h)	L 73	1		(C2) (M9) (G9) (87) (N1) (N0) (E5)
2864	Ø 64 (cm 64 x 52 h)	L 123	1		(C2) (M9) (G9) (87) (E5)
2865	Ø 74 (cm 74 x 61 h)	L 192	1		(C2) (M9) (G9) (87) (E5)





ilie | vaso • pot

art.	size						
2497	Ø 37 (cm 37 x 75 h)		L 13	A4256		1	Ⓢ C2 87 E5
2498	Ø 42 (cm 42 x 90 h)		L 19			1	Ⓢ C2 87 E5
2415	Ø 47 (cm 47 x 98 h)		L 26	A4239	A4631	1	Ⓢ C2 87 E5
2506	Ø 57 (cm 57 x 126 h)		L 54	A4240		1	Ⓢ C2 87 E5

# ilie

good for **plants**



lلدpe



kit riserva d'acqua  
water reserve kit



easy for **sales**



rifinito a mano  
hand-finished







kit fissaggio a terra  
ground fixing kit





ilie gloss | vaso • pot

art.	size							
2579	Ø 32 (cm 32 x 67 h)		L 9		A4631	1	Ⓢ	Ⓢ
2509	Ø 37 (cm 37 x 75 h)		L 13	A4256		1	Ⓢ	Ⓢ
2518	Ø 47 (cm 47 x 98 h)		L 26	A4239	A4631	1	Ⓢ	Ⓢ
2580	Ø 57 (cm 57 x 126 h)		L 54	A4240		1	Ⓢ	Ⓢ



# ilie

---

## gloss

good for **plants**

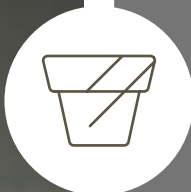

100%  
lIdpe



kit riserva d'acqua  
water reserve kit

easy for **sales**





rifinito a mano  
hand-finished





kit fissaggio a terra  
ground fixing kit



ilie | vaso • pot light (indoor)

art.	size				
2661	Ø 37 (cm 37 x 75 h)			1	98
2665	Ø 42 (cm 42 x 90 h)			1	98
2669	Ø 47 (cm 47 x 98 h)		A4631	1	98
2673	Ø 57 (cm 57 x 126 h)			1	98

ilie | vaso • pot light (outdoor)

art.	size				
2662	Ø 37 (cm 37 x 75 h)			1	98
2666	Ø 42 (cm 42 x 90 h)			1	98
2670	Ø 47 (cm 47 x 98 h)		A4631	1	98
2674	Ø 57 (cm 57 x 126 h)			1	98

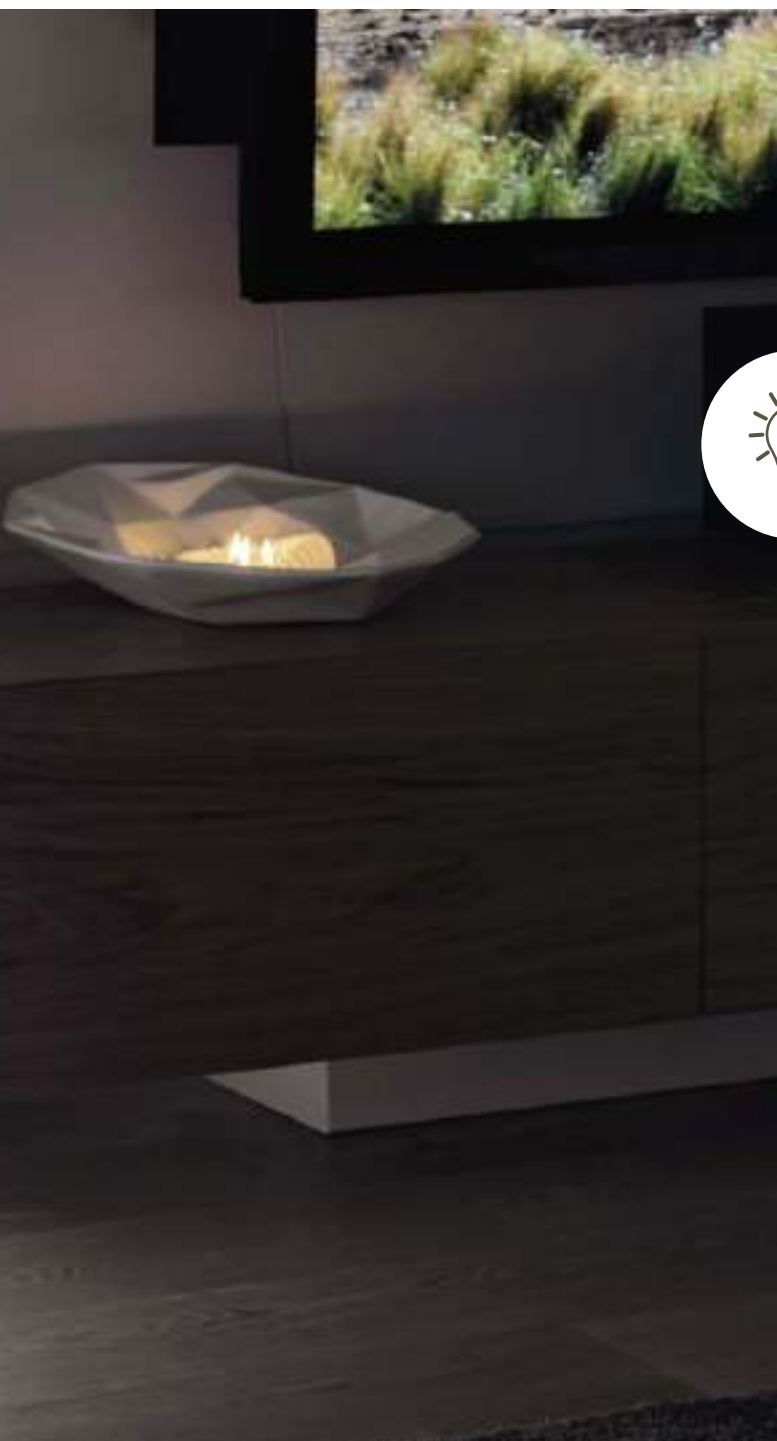

# ilie

## light

material



lIdpe

easy for sales



rifinito a mano  
hand-finished



kit fissaggio a terra  
ground fixing kit



kit luce montato  
installed light kit

220  
221

### ilie | vaso • pot rgb E27 light (indoor)

art.	size				
3091	Ø 37	(cm 37 x 75 h)		1	98
3092	Ø 42	(cm 42 x 90 h)		1	98
3093	Ø 47	(cm 47 x 98 h)	A4631	1	98
3094	Ø 57	(cm 57 x 126 h)		1	98

### ilie | vaso • pot rgb E27 light (outdoor)

art.	size				
3095	Ø 37	(cm 37 x 75 h)		1	98
3096	Ø 42	(cm 42 x 90 h)		1	98
3097	Ø 47	(cm 47 x 98 h)	A4631	1	98
3098	Ø 57	(cm 57 x 126 h)		1	98

il kit luce RGB E27 è dotato di telecomando • RGB E27 light kit with remote control



kiam | vaso quadro • square pot

art.	size				
2499	cm 35	(cm 35 x 35 x 75 h)	L 13	1	
2500	cm 40	(cm 40 x 40 x 90 h)	L 20	1	



# kiam

good for plants



lhdpe

easy for sales



















rifinito a mano  
hand-finished





kiam gloss | vaso quadro • square pot

art.	size									
2637	cm 25	(cm 25 x 25 x 56 h)	L 4,5					1		
2581	cm 30	(cm 30 x 30 x 67 h)	L 9,0	A4255	A4629	A4350		1		
2638	cm 35	(cm 35 x 35 x 75 h)	L 14,0	A4373				1		
2582	cm 40	(cm 40 x 40 x 90 h)	L 23,0	A4241	A4629			1		



# kiam

## gloss

good for **plants**

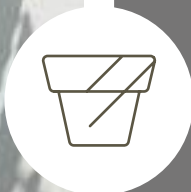

lلدpe



kit riserva d'acqua  
water reserve kit

easy for **sales**



rifinito a mano  
hand-finished





kit fissaggio a terra  
ground fixing kit





kit posacenere  
ashtray kit



**kiam** | vaso quadro • square pot light (indoor)

art.	size			
2693	<b>cm 35</b>	(cm 35 x 35 x 75 h)	1	98
2697	<b>cm 40</b>	(cm 40 x 40 x 90 h)	1	98

**kiam** | vaso quadro • square pot light (outdoor)

art.	size			
2694	<b>cm 35</b>	(cm 35 x 35 x 75 h)	1	98
2698	<b>cm 40</b>	(cm 40 x 40 x 90 h)	1	98

# kiam

## light

material



lIdpe

easy for sales



rifinito a mano  
hand-finished



kit luce montato  
installed light kit

226  
227

kiam | vaso quadro • square pot rgb E27 light (indoor)

kiam | vaso quadro • square pot rgb E27 light (outdoor)





art.	size			
3099	<b>cm 35</b>	(cm 35 x 35 x 75 h)	1	98
3100	<b>cm 40</b>	(cm 40 x 40 x 90 h)	1	98

art.	size			
3101	<b>cm 35</b>	(cm 35 x 35 x 75 h)	1	98
3102	<b>cm 40</b>	(cm 40 x 40 x 90 h)	1	98

il kit luce RGB E27 è dotato di telecomando • RGB E27 light kit with remote control



kuno gloss | vaso • pot

art.	size						
2536	Ø 40	(cm 40 x 40 h)	L14	A4256	A4631	1	Ⓒ2
2534	Ø 50	(cm 50 x 50 h)	L28	A4239	A4631	1	Ⓒ2
2535	Ø 60	(cm 60 x 60 h)	L52	A4240	A4631	1	Ⓒ2

# kuno

---

## gloss

good for **plants**



lldpe



kit riserva d'acqua  
water reserve kit

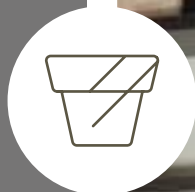

easy for **sales**



rifinito a mano  
hand-finished





kit fissaggio a terra  
ground fixing kit





quadrum | vaso quadro • square pot

art.	size					
2419	cm 37	(cm 37 x 37 x 73 h)	L 16	A4629	1	<b>87</b> 69
2420	cm 51	(cm 51 x 51 x 100 h)	L 41	A4629	1	<b>87</b> 69



# quadrum

good for plants



lلدpe



easy for sales



rifinito a mano  
hand-finished







kit fissaggio a terra  
ground fixing kit





**quadrum laccato** | vaso quadro laccato • lacquered square pot

art.	size				
*L2419	<b>cm 37</b>	(cm 37 x 37 x 73 h)	L 16	1	
*L2420	<b>cm 51</b>	(cm 51 x 51 x 100 h)	L 41	1	

\* per quantitativi minimi • for minimum orders



# quadrum

laccato • lacquered

good for plants



lldpe

easy for sales



rifinito a mano  
hand-finished

**Sottoposti a un elaborato processo di laccatura,  
si vestono di una preziosa finitura lucida.**

Having received an elaborate lacquering process,  
they have a precious gloss finish



**quadrum** | vaso quadro • square pot light (indoor)

art.	size				
2711	<b>cm 51</b>	(cm 51 x 51 x 100 h)	A4629	1	98

**quadrum** | vaso quadro • square pot light (outdoor)

art.	size				
*2712	<b>cm 51</b>	(cm 51 x 51 x 100 h)	A4629	1	98

\* con canaletta di scolo • with drainage tube

il kit luce RGB E27 è dotato di telecomando •  
RGB E27 light kit with remote control

# quadrum

## light

material



HDPE



easy for sales



rifinito a mano  
hand-finished



kit fissaggio a terra  
ground fixing kit



kit luce montato  
installed light kit

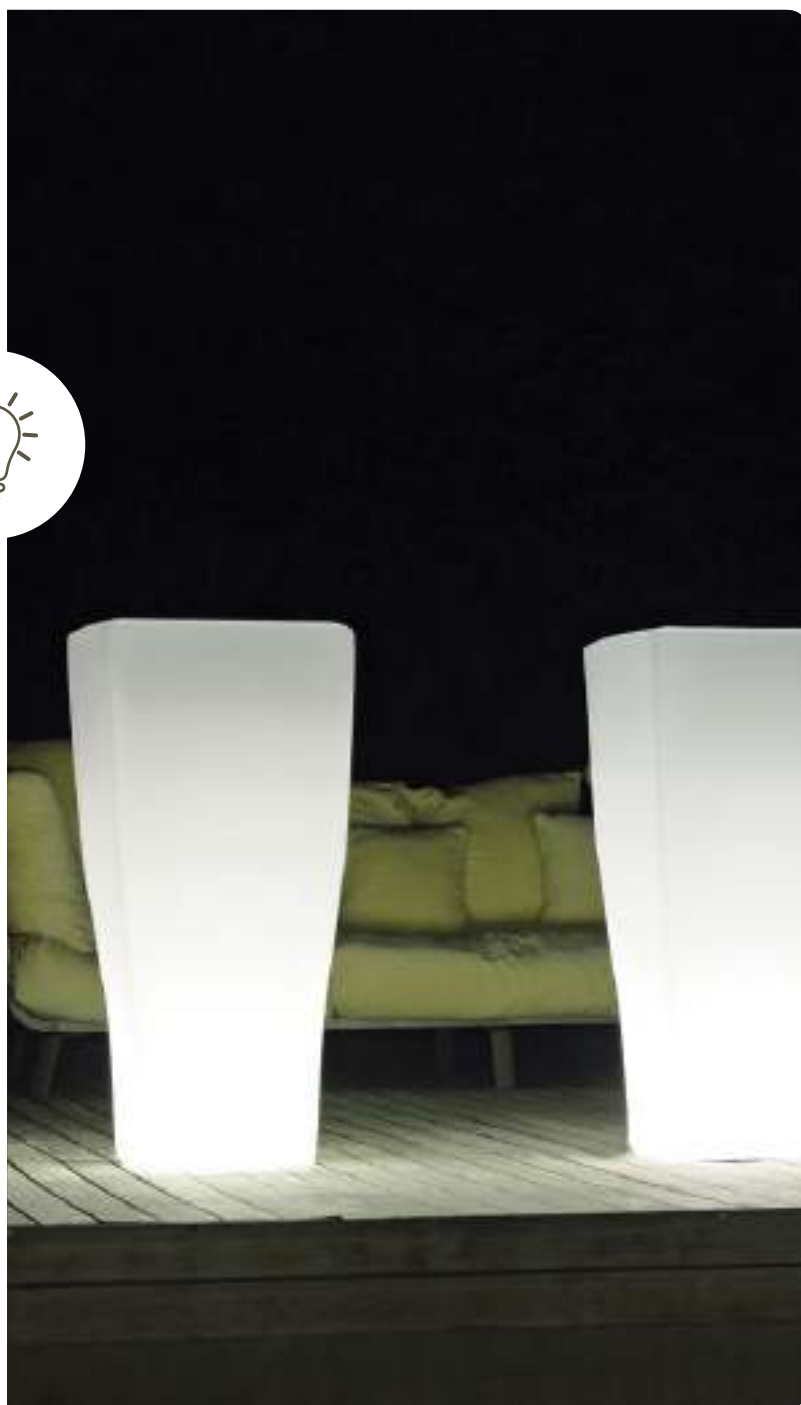

234  
235

quadrum | vaso quadro • square pot rgb E27 light (indoor)

art.	size				
3124	cm 51	(cm 51 x 51 x 100 h)	A4629	1	(98)

quadrum | vaso quadro • square pot rgb E27 light (outdoor)





art.	size				
*3125	cm 51	(cm 51 x 51 x 100 h)	A4629	1	(98)

\* con canaletta di scolo • with drainage tube

il kit luce RGB E27 è dotato di telecomando •  
RGB E27 light kit with remote control



tulum | vaso • pot

art.	size					
*2373	Ø 35	(cm 35 x 51 h)	L 18	A4629	1	87
2374	Ø 43	(cm 43 x 63 h)	L 33	A4629	1	87
2375	Ø 56	(cm 56 x 102 h)	L 91	A4629	1	87

\* per quantitativi minimi • for minimum orders

# tulum

good for plants



HDPE



easy for sales



rifinito a mano  
hand-finished







kit fissaggio a terra  
ground fixing kit





opus | vaso • pot

art.	size					
*2495	Ø 37	(cm 37 x 34 h)	L 14	A4631	1	87 E5
*2482	Ø 47	(cm 47 x 43 h)	L 26	A4631	1	87 E5
*2483	Ø 57	(cm 57 x 53 h)	L 47	A4631	1	87 E5

\* per quantitativi minimi • for minimum orders

# opus

good for plants



HDPE



easy for sales



rifinito a mano  
hand-finished













kit fissaggio a terra  
ground fixing kit







niscal | vaso • pot

art.	size					
*2496	Ø 37	(cm 37 x 34 h)	L 12	A4631	1	 
*2484	Ø 47	(cm 47 x 43 h)	L 25	A4631	1	 
*2485	Ø 57	(cm 57 x 53 h)	L 45	A4631	1	 

\* per quantitativi minimi • for minimum orders

# niscal

good for plants



11dpe



easy for sales



rifinito a mano  
hand-finished





kit fissaggio a terra  
ground fixing kit





akan | cassetta • plant box

art.	size				
2465	cm 80	(cm 80 x 40 x 33 h)	L 60	1	87 E5

# akan

good for plants



llDpe



easy for sales



rifinito a mano  
hand-finished



cassetta vaso abbinati  
matching plant box pot





242  
243

akan | vaso quadro • square pot



art.	size				
2486	cm 40	(cm 40 x 40 x 33 h)	L 25	1	87 E5





**sfera | sphere light (indoor)**

art.	size			
2639	Ø 45 (cm 45 x 40 h)		1	98
2715	Ø 55 (cm 55 x 50 h)		1	98
2718	Ø 65 (cm 65 x 60 h)		1	98



**sfera | sphere light (outdoor)**

art.	size			
2651	Ø 45 (cm 45 x 40 h)		1	98
2716	Ø 55 (cm 55 x 50 h)		1	98
2719	Ø 65 (cm 65 x 60 h)		1	98

**sfera | sphere rgb E27 light (indoor)**

art.	size			
3126	Ø 45 (cm 45 x 40 h)		1	98
3128	Ø 55 (cm 55 x 50 h)		1	98
3130	Ø 65 (cm 65 x 60 h)		1	98

**sfera | sphere rgb E27 light (outdoor)**

art.	size			
3127	Ø 45 (cm 45 x 40 h)		1	98
3129	Ø 55 (cm 55 x 50 h)		1	98
3131	Ø 65 (cm 65 x 60 h)		1	98

il kit luce RGB E27 è dotato di telecomando • RGB E27 light kit with remote control

# sfera

## light

material



lldpe

easy for sales



rifinito a mano  
hand-finished





kit luce montato  
installed light kit



244  
245

sfera a sospensione | suspended sphere light (indoor/outdoor)

art.	size			
3023	Ø 45 (cm 45 x 40 h)	1	1	98
3024	Ø 55 (cm 55 x 50 h)	1	1	98
3025	Ø 65 (cm 65 x 60 h)	1	1	98



**sfera con piedistallo** | sphere with pedestal light (indoor)

art.	size		
2759	Ø 65	(cm 65 x 70 h)	1 

**sfera con piedistallo** | sphere with pedestal light (outdoor)

art.	size		
2760	Ø 65	(cm 65 x 70 h)	1 



# sfera

## light

material



lldpe

easy for sales



rifinito a mano  
hand-finished



kit luce montato  
installed light kit

246  
247

**sfera con piedistallo** | sphere with pedestal rgb E27 light (indoor)

art.	size			
3132	Ø 65	(cm 65 x 70 h)	1	98

**sfera con piedistallo** | sphere with pedestal rgb E27 light (outdoor)

art.	size			
3133	Ø 65	(cm 65 x 70 h)	1	98

il kit luce RGB E27 è dotato di telecomando • RGB E27 light kit with remote control





**sfera mini** | mini sphere with led light kit (indoor)

art.	size		
2636	Ø 20	(cm 20 x 18 h)	1
			98



# sfera mini

---

## light

material



lIdpe

easy for **sales**













**rifinito a mano**  
hand-finished













**kit luce montato**  
installed light kit



siepi | cassetta • plant box

art.	size				
2234	cm 80	(cm 80 x 39 x 35 h)	L 76	1	   
2217	cm 100	(cm 99 x 47 x 41 h)	L 157	1	   

millerighe | sottocassetta • oblong tray

art.	size			
1887	cm 80	(cm 81 x 40 x 4 h)	1	   
1883	cm 100	(cm 100 x 47 x 4 h)	1	   



# siepi

good for plants



lIdpe



sottocassetta abbinata  
fitting oblong tray



sottovaso abbinato  
fitting saucer



easy for sales













rifinito a mano  
hand-finished









cassetta vaso abbinati  
matching plant box pot

250  
251

## siepi | vaso quadro • square pot

art.	size				
2235	cm 39	(cm 39 x 39 x 35 h)	L 32	1	   
2216	cm 47	(cm 47 x 47 x 41 h)	L 71	1	   

## neze | sottovaso quadro • square saucer

art.	size			
1630	cm 42	(cm 42 x 42 x 5,2 h)	1	 
1631	cm 48	(cm 49 x 49 x 5,6 h)	1	 



**siepi** | cassetta con doppia parete • plant box with double wall

art.	size				
2376	cm 120	(cm 120 x 55 x 48 h)	L 198	1	

**siepi** | sottocassetta • oblong tray

art.	size			
2383	cm 120	(cm 127 x 61 x 6,8 h)	1	

# siepi

good for plants



IlDpe



sottocassetta abbinata  
fitting oblong tray



sottovaso abbinato  
fitting saucer



easy for sales



rifinito a mano  
hand-finished



cassetta vaso abbinati  
matching plant box pot



252  
253

siepi | vaso quadro con doppia parete • square pot with double wall

art.	size				
2288	cm 55	(cm 55 x 55 x 48 h)	L 78	1	G9 87 45
2317	cm 71	(cm 71 x 71 x 62 h)	L 171	1	G9 87 45

neze | sottovaso quadro • square saucer



art.	size			
2093	cm 61	(cm 61 x 61 x 6,8 h)	1	87 45
2095	cm 74	(cm 74 x 74 x 8,0 h)	1	87 45

con doppia  
parete



with double  
wall



siepi | vaso • pot

art.	size				
*2309	Ø 38	(cm 38 x 35 h)	L 30	1	45
*2310	Ø 47	(cm 47 x 41 h)	L 55	1	45
*2311	Ø 52	(cm 52 x 56 h)	L 97	1	45

idria | sottovaso • saucer

art.	size			
1550	Ø 47	(cm 47 x 5,5 h)	1	45
1552	Ø 56	(cm 56 x 6,0 h)	1	45
1553	Ø 63	(cm 63 x 7,0 h)	1	45



siepi | vaso angolo • angle pot

art.	size				
2308	cm 50	(cm 50 x 36 x 56 h)	L 50	1	45

sottovaso angolo | sottovaso angolo • angle saucer

art.	size			
*1545	cm 45	(cm 45 x 41 x 4,5 h)	1	45



siepi | vaso a muro • wall pot

art.	size				
*2289	cm 52	(cm 52 x 27 x 56 h)	L 53	1	45

sottovaso a muro | sottovaso a muro • wall saucer

art.	size			
*1544	cm 57	(cm 57 x 34 x 4,5 h)	1	45



millerighe | vaso angolo • angle pot

art.	size			
*2090	cm 45	(cm 45 x 34 x 51 h)	L 33	1 <span style="border: 1px solid black; border-radius: 50%; padding: 2px;">31</span> <span style="border: 1px solid black; border-radius: 50%; padding: 2px;">45</span>

sottovaso angolo | sottovaso angolo • angle saucer

art.	size		
*1545	cm 45	(cm 45 x 41 x 4,5 h)	1 <span style="border: 1px solid black; border-radius: 50%; padding: 2px;">45</span>



millerighe | vaso a muro • wall pot

art.	size			
*2089	cm 48	(cm 48 x 26 x 56 h)	L 44	1 <span style="border: 1px solid black; border-radius: 50%; padding: 2px;">31</span> <span style="border: 1px solid black; border-radius: 50%; padding: 2px;">45</span>

sottovaso a muro | sottovaso a muro • wall saucer



art.	size		
*1544	cm 57	(cm 57 x 34 x 4,5 h)	1 <span style="border: 1px solid black; border-radius: 50%; padding: 2px;">45</span>

254  
255





doppio bordo | vaso • pot

art.	size				
1746	Ø 35	(cm 35 x 32 h)	L 15	1	45
1747	Ø 40	(cm 42 x 37 h)	L 24	1	45
1748	Ø 45	(cm 45 x 40 h)	L 32	1	45
1749	Ø 50	(cm 51 x 44 h)	L 44	1	45
1750	Ø 55	(cm 55 x 47 h)	L 60	1	45
1751	Ø 60	(cm 60 x 51 h)	L 77	1	45
1752	Ø 65	(cm 65 x 56 h)	L 100	1	45
1753	Ø 75	(cm 77 x 61 h)	L 150	1	45
1754	Ø 85	(cm 85 x 68 h)	L 210	1	45

# doppio bordo

good for plants



llDpe



sottovaso abbinato  
fitting saucer



easy for sales



rifinito a mano  
hand-finished



impilabile  
stackable



256  
257

## doppio bordo | sottovaso • saucer

art.	size			
1790	Ø 25	(cm 26 x 3,6 h)	1	45
1791	Ø 30	(cm 30 x 3,5 h)	1	45
1792	Ø 33	(cm 33 x 3,3 h)	1	45
1793	Ø 36	(cm 37 x 3,9 h)	1	45
1794	Ø 40	(cm 41 x 4,0 h)	1	45
1795	Ø 43	(cm 44 x 4,2 h)	1	45
1796	Ø 49	(cm 49 x 4,5 h)	1	45
1797	Ø 54	(cm 54 x 5,0 h)	1	45
1798	Ø 61	(cm 61 x 5,0 h)	1	45

i sottovasi possono essere ordinati solo contestualmente ai vasi cui sono abbinati e in quantità uguale, inferiore o secondo la disponibilità • these saucers may only be ordered at the same time as the pots they are matched to, and in the same or fewer quantities, depending on availability

# festonato

good for plants



100%  
lldpe



sottovaso abbinato  
fitting saucer



easy for sales



rifinito a mano  
hand-finished



impilabile  
stackable



## festonato | vaso • pot

art.	size				
1712	Ø 40	(cm 39 x 32 h)	L 20	1	45
1713	Ø 45	(cm 46 x 37 h)	L 27	1	45
1714	Ø 50	(cm 50 x 39 h)	L 38	1	45
1715	Ø 55	(cm 55 x 45 h)	L 53	1	45
2171	Ø 60	(cm 60 x 48 h)	L 71	1	45
1716	Ø 65	(cm 64 x 52 h)	L 91	1	45
1717	Ø 70	(cm 69 x 57 h)	L 118	1	45
1718	Ø 75	(cm 75 x 60 h)	L 146	1	45
1729	Ø 85	(cm 85 x 68 h)	L 215	1	45
1730	Ø 95	(cm 94 x 77 h)	L 304	1	45
1731	Ø 110	(cm 106 x 85 h)	L 401	1	45

## eur | sottovaso • saucer

art.	size			
1719	Ø 28	(cm 28 x 3,3 h)	1	45
1720	Ø 32	(cm 32 x 3,6 h)	1	45
1721	Ø 35	(cm 35 x 3,8 h)	1	45
1722	Ø 37	(cm 37 x 4,3 h)	1	45
2172	Ø 43	(cm 43 x 5,0 h)	1	45
1723	Ø 45	(cm 46 x 4,7 h)	1	45
1724	Ø 50	(cm 50 x 4,8 h)	1	45
1725	Ø 54	(cm 54 x 5,4 h)	1	45
1732	Ø 62	(cm 62 x 5,9 h)	1	45
1733	Ø 68	(cm 68 x 6,1 h)	1	45
1734	Ø 73	(cm 73 x 7,3 h)	1	45

i sottovasi possono essere ordinati solo contestualmente ai vasi cui sono abbinati e in quantità uguale, inferiore o secondo la disponibilità • these saucers may only be ordered at the same time as the pots they are matched to, and in the same or fewer quantities, depending on availability



# festonato

## special colors

good for plants



100%  
lIdpe



sottovaso abbinato  
fitting saucer

easy for sales









rifinito a mano  
hand-finished









impilabile  
stackable

258  
259

### festonato special colors | vaso • pot

art.	size				
*2973	Ø 40	(cm 39 x 32 h)	L 20	1	
*2974	Ø 45	(cm 46 x 37 h)	L 27	1	
*2975	Ø 50	(cm 50 x 39 h)	L 38	1	
*2976	Ø 60	(cm 60 x 48 h)	L 71	1	



### idria | sottovaso • saucer

art.	size			
*1547	Ø 32	(cm 32 x 5,0 h)	1	
*2138	Ø 33	(cm 33 x 4,2 h)	1	
*1548	Ø 36	(cm 36 x 5,0 h)	1	
*1550	Ø 47	(cm 47 x 5,5 h)	1	

\* per quantitativi minimi • for minimum orders



festum | vaso • pot

art.	size				
2365	Ø 40 (cm 40 x 33 h)	L 23	1	45	
2366	Ø 45 (cm 45 x 37 h)	L 33	1	45	
2367	Ø 50 (cm 50 x 41 h)	L 46	1	45	
2368	Ø 55 (cm 55 x 46 h)	L 61	1	45	
2369	Ø 60 (cm 60 x 50 h)	L 79	1	45	
2370	Ø 65 (cm 65 x 54 h)	L 100	1	45	



# festum

good for plants



lIdpe



easy for sales



rifinito a mano  
hand-finished



impilabile  
stackable

# cilindro rot

good for plants



llpe



sottovaso abbinato  
fitting saucer



easy for sales



rifinito a mano  
hand-finished



impilabile  
stackable



## cilindro rot | vaso • pot

art.	size				
2294	Ø 50	(cm 52 x 38 h)	L 50	1	G9 45
2165	Ø 60	(cm 62 x 43 h)	L 80	1	G9 45
2164	Ø 70	(cm 72 x 50 h)	L 130	1	G9 45
2163	Ø 90	(cm 90 x 63 h)	L 260	1	G9 45
*2162	Ø 110	(cm 110 x 77 h)	L 480	1	G9 45
*2161	Ø 130	(cm 130 x 91 h)	L 800	1	G9 45
*2151	Ø 150	(cm 150 x 102 h)	L 1150	1	G9 45

## cilindro | sottovaso • saucer

art.	size			
2296	Ø 50	(cm 43,5 x 4,3 h)	1	45
2170	Ø 60	(cm 51,0 x 4,4 h)	1	45
2169	Ø 70	(cm 62,0 x 4,7 h)	1	45
2168	Ø 90	(cm 75,0 x 5,6 h)	1	45
2167	Ø 110	(cm 91,0 x 6,2 h)	1	45
2166	Ø 130	(cm 107,0 x 6,9 h)	1	45
2156	Ø 150	(cm 121,0 x 7,5 h)	1	45

\* per quantitativi minimi • for minimum orders

i sottovasi possono essere ordinati solo contestualmente ai vasi cui sono abbinati e in quantità uguale, inferiore o secondo la disponibilità • these saucers may only be ordered at the same time as the pots they are matched to, and in the same or fewer quantities, depending on availability



# tempium

good for plants



lIdpe



sottovaso abbinato  
fitting saucer

easy for sales



rifinito a mano  
hand-finished



impilabile  
stackable

262  
263

## tempium | vaso • pot

art.	size				
*2075	Ø 85 (cm 85 x 66 h)		L 145	1	45
*2076	Ø 102 (cm 102 x 77 h)		L 250	1	45
*2077	Ø 114 (cm 114 x 88 h)		L 370	1	45
*2078	Ø 145 (cm 145 x 114 h)		L 850	1	45

## tempium | sottovaso • saucer

art.	size			
2103	Ø 85 (cm 52 x 5,6 h)		1	45
2104	Ø 102 (cm 64 x 5,5 h)		1	45
2105	Ø 114 (cm 70 x 5,5 h)		1	45
2106	Ø 145 (cm 89 x 6,5 h)		1	45



\* per quantitativi minimi • for minimum orders

i sottovasi possono essere ordinati solo contestualmente ai vasi cui sono abbinati e in quantità uguale, inferiore o secondo la disponibilità • these saucers may only be ordered at the same time as the pots they are matched to, and in the same or fewer quantities, depending on availability







millorighe | cassetta • plant box

art.	size				
1805	cm 60	(cm 58 x 26 x 25 h)	L 29	1	45
1806	cm 70	(cm 68 x 31 x 29 h)	L 45	1	45
1807	cm 80	(cm 77 x 35 x 32 h)	L 70	1	45
1808	cm100	(cm 97 x 44 x 38 h)	L128	1	31 45

millorighe | sottocassetta • oblong tray

art.	size			
1885	cm 60	(cm 63 x 31 x 4 h)	1	45
1886	cm 70	(cm 72 x 36 x 4 h)	1	45
1887	cm 80	(cm 81 x 40 x 4 h)	1	45
1883	cm100	(cm 100 x 47 x 4 h)	1	45



# millerighe

good for plants



lIdpe



sottocassetta abbinata  
fitting oblong tray



sottovaso abbinato  
fitting saucer



easy for sales





rifinito a mano  
hand-finished





cassetta vaso abbinati  
matching plant box pot

264  
265

## millerighe | vaso quadro • square pot

art.	size				
1809	<b>cm 25</b>	(cm 26 x 26 x 25 h)	L 11	1	45
1810	<b>cm 30</b>	(cm 31 x 31 x 29 h)	L 18	1	45
1811	<b>cm 35</b>	(cm 35 x 35 x 32 h)	L 28	1	45
1812	<b>cm 45</b>	(cm 44 x 44 x 38 h)	L 51	1	31 45
2283	<b>cm 55</b>	(cm 55 x 55 x 45 h)	L 99	1	31 45

## neze | sottovaso quadro • square saucer

art.	size			
1628	<b>cm 32</b>	(cm 32 x 32 x 4,5 h)	1	45
1629	<b>cm 36</b>	(cm 36 x 36 x 4,5 h)	1	45
1630	<b>cm 42</b>	(cm 42 x 42 x 5,2 h)	1	45
1631	<b>cm 48</b>	(cm 49 x 49 x 5,6 h)	1	45
1632	<b>cm 54</b>	(cm 55 x 55 x 6,0 h)	1	31 45



millerighe special colors | cassetta • plant box

art.	size				
*2977	cm 100	(cm 97 x 44 x 38 h)	L 128	1	P7

millerighe | sottocassetta • oblong tray

art.	size			
1883	cm 100	(cm 100 x 47 x 4 h)	1	G9

\* per quantitativi minimi • for minimum orders



# millerighe

## special colors

good for plants



lIdpe



sottocassetta abbinata  
fitting oblong tray



sottovaso abbinato  
fitting saucer

easy for sales



rifinito a mano  
hand-finished



cassetta vaso abbinati  
matching plant box pot

266  
267

millerighe special colors | vaso quadro • square pot

art.	size				
*2978	cm 45	(cm 44 x 44 x 38 h)	L 51	1	P7

neze | sottovaso quadro • square saucer

art.	size			
*1631	cm 48	(cm 49 x 49 x 5,6 h)	1	G9

\* per quantitativi minimi • for minimum orders



tere | cassetta • plant box

art.	size				
1984	cm 100	(cm 97 x 44 x 38 h)	L 128	1	45

# tere

good for plants



Ilidpe



easy for sales



rifinito a mano  
hand-finished



cassetta vaso abbinati  
matching plant box pot



268  
269

tere | vaso quadro • square pot

art.	size				
1985	cm 45	(cm 44 x 44 x 38 h)	L 51	1	45

# eden

good for **plants**



100%  
Hdpe

easy for **sales**



rifinito a mano  
hand-finished



eden | ciotola • plant bowl

art.	size				
1257	Ø 43	(cm 43 x 21 h)	L 11	1	32



# giottus

good for plants



lIdpe



sottovaso abbinato  
fitting saucer



easy for sales



rifinito a mano  
hand-finished



impilabile  
stackable

270  
271

## giottus | ciotola • plant bowl

art.	size				
*2139	Ø 30	(cm 30 x 13 h)	L 4	1	45
*2140	Ø 42	(cm 42 x 17 h)	L 11	1	45
*2141	Ø 55	(cm 55 x 22 h)	L 25	1	45
*2284	Ø 70	(cm 73 x 28 h)	L 71	1	45
*2142	Ø 85	(cm 85 x 31 h)	L 86	1	45
*2143	Ø 100	(cm 100 x 36 h)	L 120	1	45
*2066	Ø 130	(cm 130 x 43 h)	L 250	1	45

## idria | sottovaso • saucer

art.	size			
2135	Ø 22	(cm 22 x 3,4 h)	1	45
1546	Ø 30	(cm 30 x 5,0 h)	1	45
1548	Ø 36	(cm 36 x 5,0 h)	1	45
1551	Ø 53	(cm 53 x 5,5 h)	1	45
1552	Ø 56	(cm 56 x 6,0 h)	1	45
1553	Ø 63	(cm 63 x 7,0 h)	1	45
1587	Ø 77	(cm 77 x 7,5 h)	1	45

\* per quantitativi minimi • for minimum orders



lik

good for plants



lhdpe

easy for sales



rifinito a mano  
hand-finished



impilabile  
stackable



lik | vaso • pot

art.	size				
2285	Ø 37	(cm 37 x 49 h)	L 30	1	87
2286	Ø 42	(cm 42 x 55 h)	L 46	1	87
2287	Ø 47	(cm 47 x 62 h)	L 64	1	87



# tum

good for plants



lIdpe



sottovaso abbinato  
fitting saucer



easy for sales





rifinito a mano  
hand-finished





impilabile  
stackable

272  
273

## tum | vaso quadro • square pot

art.	size				
*2214	cm 37	(cm 37 x 37 x 49 h)	L 38	1	45
*2215	cm 42	(cm 42 x 42 x 55 h)	L 57	1	45
*2295	cm 47	(cm 47 x 47 x 61 h)	L 80	1	45

## neze | sottovaso • square saucer

art.	size			
1628	cm 32	(cm 32 x 32 x 4,5 h)	1	45
1629	cm 36	(cm 36 x 36 x 4,5 h)	1	45
1630	cm 42	(cm 42 x 42 x 5,2 h)	1	45

\* per quantitativi minimi • for minimum orders





**toscana** | cassetta con doppia parete •  
plant box with double wall



art.	size				
*1128	cm 100	(cm 95 x 47 x 47 h)	L 84	1	45





**toscana** | vaso quadro con doppia parete •  
square pot with double wall

art.	size				
*1129	cm 50	(cm 47 x 47 x 47 h)	L 35	1	45
*1435	cm 65	(cm 67 x 67 x 62 h)	L 107	1	45

**neze** | sottovaso quadro • square saucer

art.	size			
1632	cm 54	(cm 55 x 55 x 6,0 h)	1	45
2094	cm 68	(cm 68 x 68 x 7,3 h)	1	45



**balaustra liscia | cassetta • plant box**

art.	size				
2357	cm 50	(cm 50 x 25 x 26 h)	L 25	1	45
2358	cm 60	(cm 60 x 25 x 26 h)	L 30	1	45
2359	cm 80	(cm 80 x 25 x 26 h)	L 40	1	45
2248	cm100	(cm 100 x 25 x 26 h)	L 50	1	45

**kubis | vaso quadro • square pot**

art.	size				
*2208	cm 80	(cm 80 x 80 x 65 h)	L 280	1	45

**balaustra festonata | sottocassetta • oblong tray**

art.	size			
2379	cm 50	(cm 53 x 27 x 3,7 h)	1	45
2380	cm 60	(cm 63 x 27 x 3,7 h)	1	45
1824	cm 80	(cm 80 x 28 x 3,8 h)	1	45
1825	cm100	(cm 102 x 28 x 4,0 h)	1	45

 274  
 275



**festone | cassetta • plant box**

art.	size				
*1847	cm 50	(cm 47 x 23 x 17 h)	L 13	1	45

**festone | cassetta • plant box**

art.	size				
*1848	cm 60	(cm 63 x 24 x 20 h)	L 20	1	45

**festone | sottocassetta • oblong tray**

art.	size			
*1760	cm 50	(cm 52 x 28 x 4 h)	1	45

**festone | sottocassetta • oblong tray**



art.	size			
*1761	cm 60	(cm 67 x 29 x 4 h)	1	45



festone | cassetta • plant box

art.	size				
*1849	cm 70	(cm 71 x 31 x 29 h)	L 44	1	45



festone | cassetta • plant box

art.	size				
*1850	cm 90	(cm 87 x 39 x 30 h)	L 83	1	45
*1851	cm 100	(cm 100 x 41 x 34 h)	L 112	1	45

festone | sottocassetta • oblong tray



art.	size			
*1762	cm 70	(cm 77 x 33 x 4 h)	1	45

festone | sottocassetta • oblong tray



art.	size			
*1763	cm 90	(cm 90 x 43 x 4 h)	1	45
*1826	cm 100	(cm 104 x 43 x 4 h)	1	45



**balastra festonata | cassetta • plant box**



art.	size				
1443	cm 80	(cm 78 x 24 x 25 h)	L 36	1	45
1433	cm 100	(cm 98 x 24 x 25 h)	L 47	1	45

**balastra festonata | sottocassetta • oblong tray**

art.	size			
1824	cm 80	(cm 80 x 28 x 3,8 h)	1	45
1825	cm 100	(cm 102 x 28 x 4,0 h)	1	45



**flor | cassetta • plant box**

art.	size				
*2068	cm 67	(cm 67 x 24 x 26 h)	L 22	1	32 45
*2069	cm 77	(cm 77 x 27 x 30 h)	L 35	1	32 45
*2070	cm 97	(cm 97 x 32 x 35 h)	L 60	1	32 45



**tuliki | cassetta • plant box**

art.	size				
*1875	cm 100	(cm 97 x 38 x 44 h)	L 90	1	45

**tuliki | vaso quadro • square pot**



art.	size				
*1876	cm 40	(cm 37 x 37 x 41 h)	L 30	1	45



**foglie | cassetta • plant box**

art.	size			
*1087	cm 100	(cm 96 x 38 x 40 h)	L 98	1 (32)

**foglie | sottocassetta • oblong tray**

art.	size		
*1816	cm 100	(cm 94 x 37 x 5,4 h)	1 (32)



**foglie | vaso quadro • square pot**

art.	size			
*1088	cm 40	(cm 38 x 38 x 40 h)	L 35	1 (32)



# ulivum

good for **plants**



lIdpe



sottovaso abbinato  
fitting saucer



easy for **sales**



rifinito a mano  
hand-finished



## ulivum | conca • conch

art.	size				
2173	Ø 115	(cm 115 x 81 h)	L 555	1	45
2121	Ø 148	(cm 148 x 96 h)	L 1100	1	45

## ulivum | sottovaso • saucer

art.	size			
2174	Ø 115	(cm 90 x 6 h)	1	45
2127	Ø 148	(cm 118 x 7 h)	1	45

i sottovasi possono essere ordinati solo contestualmente ai vasi cui sono abbinati e in quantità uguale, inferiore o secondo la disponibilità • these saucers may only be ordered at the same time as the pots they are matched to, and in the same or fewer quantities, depending on availability



# decorata

good for plants



lIdpe



sottovaso abbinato  
fitting saucer



easy for sales



rifinito a mano  
hand-finished



impilabile  
stackable

280  
281

decorata | conca • conch

art.	size				
*2144	Ø 80	(cm 80 x 53 h)	L 170	1	45

decorata | sottovaso • saucer

art.	size			
2084	Ø 80	(cm 66 x 5,5 h)	1	45

\* per quantitativi minimi • for minimum orders

i sottovasi possono essere ordinati solo contestualmente ai vasi cui sono abbinati e in quantità uguale, inferiore o secondo la disponibilità • these saucers may only be ordered at the same time as the pots they are matched to, and in the same or fewer quantities, depending on availability

# ornato

good for **plants**



lIdpe



sottovaso abbinato  
fitting saucer

easy for **sales**



rifinito a mano  
hand-finished



impilabile  
stackable

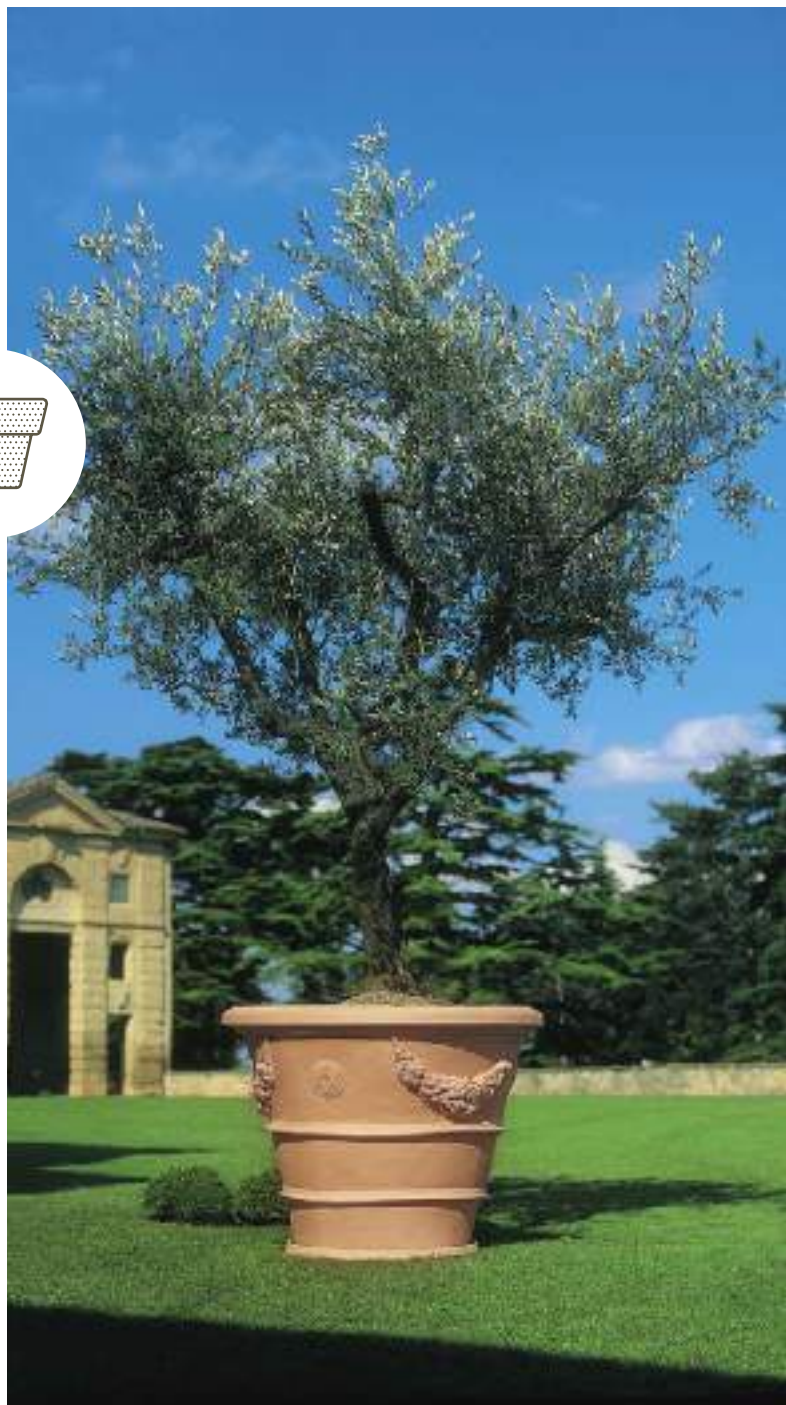

## ornato | vaso • pot

art.	size				
*2071	Ø 87	(cm 87 x 67 h)	L 150	1	45
*2072	Ø 102	(cm 102 x 78 h)	L 270	1	45
*2073	Ø 114	(cm 114 x 88 h)	L 480	1	45
*2074	Ø 150	(cm 150 x 115 h)	L 850	1	45

## ornato | sottovaso • saucer

art.	size			
2099	Ø 87	(cm 55 x 6,0 h)	1	45
2100	Ø 102	(cm 68 x 6,5 h)	1	45
2101	Ø 114	(cm 75 x 6,0 h)	1	45
2102	Ø 150	(cm 90 x 6,7 h)	1	45

\* per quantitativi minimi • for minimum orders

i sottovasi possono essere ordinati solo contestualmente ai vasi cui sono abbinati e in quantità uguale, inferiore o secondo la disponibilità • these saucers may only be ordered at the same time as the pots they are matched to, and in the same or fewer quantities, depending on availability



# angeli

good for plants



lIdpe



sottovaso abbinato  
fitting saucer



easy for sales





rifinito a mano  
hand-finished





impilabile  
stackable

282  
283

## angeli | vaso • pot

art.	size				
*1937	Ø 60	(cm 60 x 45 h)	L 50	1	45
*2079	Ø 80	(cm 80 x 60 h)	L 110	1	45
*2080	Ø 103	(cm 103 x 76 h)	L 265	1	45
*2081	Ø 147	(cm 147 x 114 h)	L 930	1	45

## angeli | sottovaso • saucer



art.	size			
2108	Ø 60	(cm 42 x 5,0 h)	1	45
2096	Ø 80	(cm 48 x 5,0 h)	1	45
2097	Ø 103	(cm 62 x 5,5 h)	1	45
2098	Ø 147	(cm 91 x 6,3 h)	1	45

\* per quantitativi minimi • for minimum orders



i sottovasi possono essere ordinati solo contestualmente ai vasi cui sono abbinati e in quantità uguale, inferiore o secondo la disponibilità • these saucers may only be ordered at the same time as the pots they are matched to, and in the same or fewer quantities, depending on availability





**camelie liscio | vaso • pot**

art.	size				
*1962	Ø 23	(cm 23 x 20 h)	L 2	1	45
*1963	Ø 38	(cm 38 x 36 h)	L 14	1	45
*1964	Ø 46	(cm 46 x 47 h)	L 29	1	45
*1965	Ø 58	(cm 58 x 62 h)	L 57	1	45
*1966	Ø 70	(cm 70 x 67 h)	L 95	1	45



**camelie liscio | sottovaso • saucer**

art.	size			
1967	Ø 23	(cm 17 x 2,7 h)	1	45
1968	Ø 38	(cm 29 x 3,8 h)	1	45
1969	Ø 46	(cm 33 x 3,9 h)	1	45
1970	Ø 58	(cm 42 x 4,3 h)	1	45
1971	Ø 70	(cm 50 x 4,5 h)	1	45

**etrus | vaso • pot**

art.	size				
*2314	Ø 25	(cm 26 x 20 h)	L 6	1	45
*2315	Ø 30	(cm 31 x 24 h)	L 11	1	45
*2242	Ø 35	(cm 36 x 29 h)	L 16	1	45
*2243	Ø 40	(cm 42 x 32 h)	L 25	1	45
*2082	Ø 45	(cm 46 x 38 h)	L 40	1	45
*2280	Ø 52	(cm 52 x 41 h)	L 47	1	45
*2281	Ø 57	(cm 57 x 45 h)	L 61	1	45
*2282	Ø 63	(cm 63 x 49 h)	L 80	1	45



**idria | sottovaso • saucer**

art.	size			
2135	Ø 22	(cm 22 x 3,4 h)	1	45
2136	Ø 25	(cm 25 x 3,6 h)	1	45
1546	Ø 30	(cm 30 x 5,0 h)	1	45
1547	Ø 32	(cm 32 x 5,0 h)	1	45
1548	Ø 36	(cm 36 x 5,0 h)	1	45
1549	Ø 41	(cm 41 x 5,0 h)	1	45
1550	Ø 47	(cm 47 x 5,5 h)	1	45
1551	Ø 53	(cm 53 x 5,5 h)	1	45



\* per quantitativi minimi • for minimum orders

i sottovasi possono essere ordinati solo contestualmente ai vasi cui sono abbinati e in quantità uguale, inferiore o secondo la disponibilità • these saucers may only be ordered at the same time as the pots they are matched to, and in the same or fewer quantities, depending on availability

**idria** | sottovaso • saucer



art.	size			
2135	Ø 22	(cm 22 x 3,4 h)	1	45
2136	Ø 25	(cm 25 x 3,6 h)	1	45
2137	Ø 28	(cm 28 x 4,0 h)	1	45
1546	Ø 30	(cm 30 x 5,0 h)	1	45
1547	Ø 32	(cm 32 x 5,0 h)	1	45
2138	Ø 33	(cm 33 x 4,2 h)	1	45
1548	Ø 36	(cm 36 x 5,0 h)	1	45
1549	Ø 41	(cm 41 x 5,0 h)	1	45
2293	Ø 44	(cm 44 x 5,2 h)	1	45
1550	Ø 47	(cm 47 x 5,5 h)	1	45
2312	Ø 50	(cm 50 x 5,6 h)	1	45
1551	Ø 53	(cm 53 x 5,5 h)	1	45
1552	Ø 56	(cm 56 x 6,0 h)	1	45
1553	Ø 63	(cm 63 x 7,0 h)	1	87 45
2313	Ø 70	(cm 70 x 7,1 h)	1	45
1587	Ø 77	(cm 77 x 5,5 h)	1	45

**rondò** | sottovaso con ruote montate • saucer with attached wheels



art.	size			
*1570	Ø 30	(cm 30 x 9,5 h)	1	45
*1571	Ø 32	(cm 32 x 9,7 h)	1	45
*1572	Ø 36	(cm 36 x 10,1 h)	1	45
*1573	Ø 41	(cm 41 x 10,7 h)	1	45
*1574	Ø 47	(cm 47 x 11,0 h)	1	45
*1575	Ø 53	(cm 53 x 12,9 h)	1	45
*1576	Ø 56	(cm 56 x 13,3 h)	1	45
*1577	Ø 63	(cm 63 x 13,7 h)	1	45
*1646	Ø 70	(cm 70 x 15,0 h)	1	45
*1589	Ø 77	(cm 78 x 15,5 h)	1	45



neze | sottovaso quadro • square saucer



art.	size			
1628	cm 32	(cm 32 x 32 x 4,5 h)	1	87 45
1629	cm 36	(cm 36 x 36 x 4,5 h)	1	87 45
1630	cm 42	(cm 42 x 42 x 5,2 h)	1	87 45
1631	cm 48	(cm 49 x 49 x 5,6 h)	1	87 45
1632	cm 54	(cm 55 x 55 x 6,0 h)	1	31 45
2093	cm 61	(cm 61 x 61 x 6,8 h)	1	87 45
2094	cm 68	(cm 68 x 68 x 7,3 h)	1	45
2095	cm 74	(cm 74 x 74 x 8,0 h)	1	87 45

millerighe | sottocassetta • oblong tray

art.	size			
1885	cm 60	(cm 63 x 31 x 4 h)	1	45
1886	cm 70	(cm 72 x 36 x 4 h)	1	45
1887	cm 80	(cm 81 x 40 x 4 h)	1	C2 G9 87 45
1883	cm 100	(cm 100 x 47 x 4 h)	1	C2 G9 87 45



**festone** | sottocassetta • oblong tray

art.	size			
*1760	cm 50	(cm 52 x 28 x 4 h)	1	45
*1761	cm 60	(cm 67 x 29 x 4 h)	1	45
*1762	cm 70	(cm 77 x 33 x 4 h)	1	45
*1763	cm 90	(cm 90 x 43 x 4 h)	1	45
*1826	cm 100	(cm 104 x 43 x 4 h)	1	45

**leone** | piedino • little base

art.			
*1556	(cm 18 x 13 x 14 h)	25	45



# orcio

good for plants



lldpe



easy for sales



rifinito a mano  
hand-finished



## orcio | orcio • pitcher

art.	size			
*1866	Ø 30	(cm 31 x 36 h)	1	45
*1867	Ø 40	(cm 42 x 44 h)	1	45
*1868	Ø 50	(cm 54 x 60 h)	1	45
*1869	Ø 60	(cm 57 x 68 h)	1	45
*1870	Ø 70	(cm 70 x 78 h)	1	45
*1871	Ø 100	(cm 97 x 96 h)	1	45

\* per quantitativi minimi • for minimum orders



# orcio impluvium

good for plants



HDPE

easy for sales



rifinito a mano  
hand-finished

288  
289

orcio impluvium | orcio con rubinetto • pitcher with tap

art.	size				
*1582	Ø 100	(cm 97 x 96 h)	L 385	1	31

\* per quantitativi minimi • for minimum orders



**ariete** | fioriera • vase

art.	size			
*1947	cm 70	(cm 68 x 100 h)	L 99	1 <span style="border: 1px solid black; border-radius: 50%; padding: 2px;">32</span>

**basamento** | basamento • base

art.		
1252	(cm 41 x 40 x 72 h)	1 <span style="border: 1px solid black; border-radius: 50%; padding: 2px;">32</span>



**putti** | fioriera • vase



art.	size			
1328	Ø 60	(cm 60 x 75 h)	L 60	1 <span style="border: 1px solid black; border-radius: 50%; padding: 2px;">32</span>

**basamento** | basamento • base

art.		
1252	(cm 41 x 40 x 72 h)	1 <span style="border: 1px solid black; border-radius: 50%; padding: 2px;">32</span>



**turfan** | fioriera • vase



art.	size			
*1940	Ø 30	(cm 30 x 34 h)	L 2	1 <span style="border: 1px solid black; border-radius: 50%; padding: 2px;">32</span>
*1368	Ø 43	(cm 43 x 48 h)	L 19	1 <span style="border: 1px solid black; border-radius: 50%; padding: 2px;">32</span>

**pamir** | basamento • base

art.		
*1367	(cm 43 x 43 x 38 h)	1 <span style="border: 1px solid black; border-radius: 50%; padding: 2px;">32</span>



**impero** | fioriera • vase



art.	size				
*1945	Ø 35	(cm 36 x 47 h)	L 5	1	32
*1946	Ø 50	(cm 48 x 60 h)	L 16	1	32
*1237	Ø 65	(cm 65 x 79 h)	L 36	1	32

**basamento** | basamento • base

art.			
1252	(cm 41 x 40 x 72 h)	1	32



**etrusca** | fioriera • vase

art.	size				
1939	Ø 25	(cm 25 x 33 h)	L 2	1	32
1944	Ø 40	(cm 38 x 42 h)	L 7	1	32
1181	Ø 50	(cm 48 x 54 h)	L 20	1	32
1213	Ø 65	(cm 61 x 71 h)	L 30	1	32

290  
291

**basamento** | basamento • base

art.			
1252	(cm 41 x 40 x 72 h)	1	32



**hermes** | fioriera ovale • oval vase

art.	size.				
*1735	cm 82	(cm 82 x 53 x 57 h)	L 46	1	32



pashà & oasis

art.			
*1311	poltroncina • small armchair <b>pashà</b>	(cm 78 x 70 x 77 h)	1 
*1312	tavolino • small table <b>oasi</b>	(cm 68 x 50 h)	1 

\* per quantitativi minimi • for minimum orders



# pashà & oasi

good for plants



llDpe

easy for sales



rifinito a mano  
hand-finished



**venere milo** | statua • statue

art.		
*1416	(cm 42 x 41 x 162 h)	1 (32)

**pamir grande** | basamento • base

art.		
*1437	(cm 43 x 43 x 38 h)	1 (32)

**venere milo piccola** | statua • statue

art.		
*1417	(cm 32 x 33 x 115 h)	1 (32)

**pamir** | basamento • base

art.		
*1367	(cm 43 x 43 x 38 h)	1 (32)

**venere milo mini** | statua • statue

art.		
*1740	(cm 21 x 20 x 85 h)	1 (32)

**thera** | basamento • base

art.		
*1536	(cm 35 x 35 x 40 h)	1 (32)



**venere** | statua • statue

art.		
*1222	(cm 41 x 38 x 165 h)	1 (32)

**pedistallo per statua** | pedestal for statue

art.		
*1223	(cm 48 x 38 h)	1 (32)

**venere piccola** | statua • statue

art.		
*1418	(cm 33 x 31 x 115 h)	1 (32)

**pamir** | basamento • base

art.		
*1367	(cm 43 x 43 x 38 h)	1 (32)

**venere mini** | statua • statue

art.		
*1739	(cm 23 x 22 x 85 h)	1 (32)

**thera** | basamento • base

art.		
*1536	(cm 35 x 35 x 40 h)	1 (32)



**putto toscano** | statua • statue

art.			
*1542	(cm 32 x 25 x 82 h)	1	32

**thera** | basamento • base

art.			
*1536	(cm 35 x 35 x 40 h)	1	32

**leone** | statua • statue

art.			
*1561	(cm 41 x 21 x 52 h)	1	32
*1251	(cm 52 x 26 x 63 h)	1	32
*1426	(cm 48 x 29 x 77 h)	1	32



**basamento** | basamento • base

art.			
1252	(cm 41 x 40 x 72 h)	1	32





**quattro stagioni | statua • statue**



art.			
*1540	primavera	(cm 41 x 33 x 119 h)	1 <span>32</span>
*1538	estate	(cm 37 x 34 x 121 h)	1 <span>32</span>

**quattro stagioni | basamento • base**

art.		
*1541	(cm 45 x 19 h)	1 <span>32</span>



**quattro stagioni | statua • statue**

art.			
*1537	autunno	(cm 38 x 32 x 122 h)	1 <span>32</span>
*1539	inverno	(cm 39 x 34 x 122 h)	1 <span>32</span>

**quattro stagioni | basamento • base**

art.		
*1541	(cm 45 x 19 h)	1 <span>32</span>



**donna francese | busto • bust**

art.		
*1602	(cm 37 x 22 x 50 h)	1 <span>32</span>

**lindos | colonna • column**

art.	size.		
*1604	h 40	(cm 36 x 40 h)	1 <span>32</span>



**venere** | busto • bust

art.		
*1355	(cm 34 x 25 x 57 h)	1 (32)



**cesare augusto** | busto • bust

art.		
*1330	(cm 60 x 30 x 72 h)	1 (32)



**pompei | capitello quadro • square capital**

art.		
*1460	(cm 50 x 50 x 71 h)	1 (32)



**rodi | colonna • column**

art.	size.		
*1659	h 236	(cm 45 x 45 x 236 h)	1 (32)

**rodi | capitello • capital**

art.		
*1660	(cm 45 x 45 x 34 h)	1 (32)



**pompei | colonna • column**

art.	size.		
*1297	h 210	(cm 43 x 43 x 210 h)	1 (32)

**creta | colonna • column**

art.	size.		
*1298	h 110	(cm 44 x 44 x 105 h)	1 (32)





**kos** | colonna • column

art.	size.		
*1603	<b>h 70</b>	(cm 38 x 38 x 70 h)	1 <span style="border: 1px solid black; border-radius: 50%; padding: 2px;">32</span>



**lindos** | colonna • column

art.	size.		
*1604	<b>h 40</b>	(cm 36 x 40 h)	1 <span style="border: 1px solid black; border-radius: 50%; padding: 2px;">32</span> *
1605	<b>h 69</b>	(cm 36 x 69 h)	1 <span style="border: 1px solid black; border-radius: 50%; padding: 2px;">32</span>



**zetis** | colonna • column

art.	size.		
*2120	<b>h 92</b>	(cm 40 x 92 h)	1 <span style="border: 1px solid black; border-radius: 50%; padding: 2px;">32</span>



**panchina semitonda** | panchina semitonda •  
half-round bench

art.		
*1305	(cm 135 x 45 x 45 h)	1 (32)



**paracarro con catena** | paracarro con catena •  
post with chain

art.		
*1260	(cm 35 x 35 x 74 h)	1 (32)



**pilastro per balaustra** | pilastro per balaustra •  
balustrade pilaster

art.		
*1304	(cm 41 x 41 x 87 h)	1 (32)



**balaustra** | balaustra • balustrade

art.			
*1302	(cm 116 x 35 x 87 h)	1	32



**balaustra per fiori** | balaustra per fiori • balustrade for flowers

art.			
*1303	(cm 116 x 35 x 87 h)	1	32

300  
301



**conchiglia** | fontana • fountain

art.   |  
\*1422 | (cm 67 x 45 x 121 h) | 1 | 32

fontana con attacco acqua • fountain w/water connection

\*1428 | (cm 67 x 45 x 121 h) | 1 | 32



**nettuno** | fontana • fountain

art.   |  
\*1369 | (cm 59 x 54 x 123 h) | 1 | 08



**pamir** | basamento • base

art.   |  
\*1367 | (cm 43 x 43 x 38 h) | 1 | 32





basamento | basamento • base

art.		
1252	(cm 41 x 40 x 72 h)	1 (32)





sasso | stone

art.	size		
*1578	cm 29	(cm 29 x 22 x 20 h)	1 (32)
*1579	cm 38	(cm 38 x 28 x 24 h)	1 (32)
*1580	cm 48	(cm 45 x 33 x 34 h)	1 (32)
*1581	cm 57	(cm 57 x 57 x 33 h)	1 (32)

302  
303



akuar | portaombrelli • umbrella-stand

art.	size.		
*2065	cm 34	(cm 34 x 47 h)	1 (45)

\* per quantitativi minimi • for minimum orders





**trio** | espositore per vasi e cassette •  
pot and plant box display

art.		
*1882	(cm 121 x 60 x 51 h)	1 <span style="border: 1px solid black; border-radius: 50%; padding: 2px;">17</span>





**steccato base** | fence with base

art.		
*1560	(cm 134 x 40 x 100 h)	1 <span style="border: 1px solid black; border-radius: 50%; padding: 2px;">17</span>





**truk** | carrello con timone •  
wagon with handle

art.		
*2149	(cm 110 x 57 x 42 h)	1 <span style="border: 1px solid black; border-radius: 50%; padding: 2px;">09</span>
port. max. 60 Kg		



**plant** | cassetta per legna con ruote montate •  
firewood log holder with attached wheels

art.				
*2249	(cm 62 x 37 x 38 h)	L 42	1	35

# Avvertenze

## Warnings

**1. Tutti i prodotti sono utilizzabili sia negli spazi interni che esterni.**

The entire range of products can be used indoors or outdoors.

**2. Non posizionare l'articolo su una superficie irregolare o inclinata, per evitare movimenti incontrollati.**

Do not position the product on an uneven or sloping surface; this will avoid uncontrolled movements.

**3. Tenere l'articolo lontano da fonti di calore.**

Keep the article away from heat sources.

**4. Gli articoli con pareti dritte realizzati con la tecnica "rotazionale" possono presentare delle non planarità (warpage) che potrebbero accentuarsi qualora il prodotto venisse esposto alla luce diretta del sole.**

Products with straight walls made using the rotational moulding system may show some warping that could become more obvious if the pot is exposed to direct sunlight.

**5. Pulire gli articoli con una spugna bagnata con acqua e detergente liquido neutro. Risciacquare con un panno bagnato. Si raccomanda di evitare l'uso di panni abrasivi e di detersivi contenenti solventi e/o alcool etilico. In caso di sporco ostinato richiedere il detergente Euro3plast.**

Clean the articles with a damp cloth and neutral liquid detergent. Rinse with a clean damp cloth Do not use abrasive cloths or cleaning agents containing solvents and/or ethyl alcohol. For stubborn stains use the special Euro3plast detergent.

---

## LIGHTS

**1. Tutte le lampade presenti in questo catalogo dispongono di un kit luce già installato.**

All the lamps included in this catalogue are supplied with a light kit already installed.

**2. In caso di sostituzione della lampadina, assicurarsi che la presa di corrente sia scollegata.**

Before replacing a bulb make sure that the power plug has been disconnected.

**3. Collegare la spina dell'apparecchio in una presa collocata in un luogo protetto dalla pioggia e dagli spruzzi d'acqua.**

Connect the plug of the appliance to a power outlet that is located in a sheltered position, protected from rain and water splashes.

**4. L'articolo "Sfera a sospensione" che monta il kit a sospensione (A4596), se utilizzato all'esterno, dovrà essere posizionato in luogo coperto.**

If used outdoors, the article "Suspended light sphere" that mounts the suspension kit (A4596) must be installed in a covered context.

**5. Se il cavo flessibile esterno di questo apparecchio viene danneggiato, deve essere sostituito esclusivamente dal costruttore, dal suo servizio di assistenza, o da personale qualificato equivalente, al fine di evitare pericoli.**

If the external flexible cable of this appliance is damaged it must be replaced by either the manufacturer, the manufacturer's customer assistance service or by equivalent qualified personnel, in order to prevent possible hazards.

**6. Nelle versioni sprovviste di interruttore sul cavo di alimentazione, collegare la spina dell'apparecchio sotto una presa comandata da interruttore.**

For models that are not equipped with an inline on/off switch, connect the plug of the appliance to a switch controlled outlet.

**7. Si sconsiglia l'utilizzo e/o l'installazione dei prodotti luminosi su superfici/pavimentazioni non solide (sabbia, terra, erba, sassi, ghiaia, ecc.). Inoltre, i prodotti luminosi non dovranno essere installati in prossimità (adiacenti e sullo stesso piano) di piscine e/o ambienti d'acqua.**

The use and/or installation of illumination devices on instable surfaces/floors or pavement (sand, soil, grass, stones, gravel, etc.) is discouraged. Neither must illumination devices be installed near (adjacent to or on the same level as) swimming pools and/or other water environments.

**8. Gli oggetti luminosi, se allestiti con terra, piante e/o vasi, dovranno essere fissati al suolo con i nostri sistemi di ancoraggio, ove previsti.**

If light articles are set up with soil, plants and/or vases, they must be secured to the ground with our anchoring systems, where provided.

**9. I vasi light outdoor sono dotati di fori di drenaggio all'interno e sul fondo del vaso, oppure di canaletta di scolo. Entrambe le soluzioni servono per favorire la fuoriuscita dell'acqua in eccesso.**

The light outdoor pots have drainage holes inside and on the base, or a drainage tube. Both solutions are to allow excess water to drain away.

**10. La serie DUO in versione light non può essere allestita con terra, piante, vasi o con oggetti vari.**

The light version of the DUO series cannot be set up with soil, plants, vases or various other objects.

**11. La serie IKON in versione light non può essere allestita con terra, piante, vasi o con oggetti vari.**

The light version of the IKON series cannot be set up with soil, plants, vases or various other objects.

**12. Euro3Plast S.p.A. declina ogni responsabilità per danni causati a cose o a persone da un uso improprio del prodotto.**

Euro3Plast S.p.A. cannot accept liability for any damage caused to things or persons by an incorrect use of the product.

# Kit luce

## Light kit

### kit luce in PC per **interni** **indoor** PC light kit

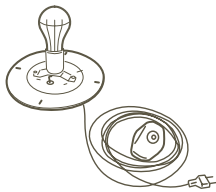

Il kit luce è compatibile con lampadine di classi energetiche E → A++, ed è venduto con una lampada di classe energetica A++.

The light kit is compatible with bulbs of the energy class E → A++, and is sold with a bulb of the energy class A++.

art. A4279

dettagli • details

**piastra in policarbonato** • polycarbonate plate  
**cavo trasparente** • transparent cable  
**pulsantiera a pedale** • foot switch  
**spina europea bipolare** • european bipolar plug  
**lunghezza cavo** • wire length: **cm 370**

luce • light  
1 x 8,5 W



### kit luce in PC per **esterni** **outdoor** PC light kit

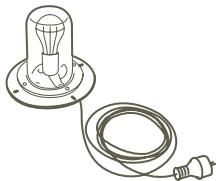

Il kit luce è compatibile con lampadine di classi energetiche E → A++, ed è venduto con una lampada di classe energetica A++.

The light kit is compatible with bulbs of the energy class E → A++, and is sold with a bulb of the energy class A++.

art. A4280

dettagli • details

**piastra in policarbonato** • polycarbonate plate  
**guscio in policarbonato** • polycarbonate shell  
**guarnizione a tenuta** • gasket seal  
**cavo nero** • black cable  
**spina schuko antispruzzo** • anti-splash  
**lunghezza cavo** • wire length: **cm 280**

luce • light  
1 x 8,5 W



### kit luce in PC RGB E27 per **interni** **indoor** PC RGB E27 light kit



Il kit luce è compatibile con lampadine di classi energetiche E → A++, ed è venduto con una lampada di classe energetica A.

The light kit is compatible with bulbs of the energy class E → A++, and is sold with a bulb of the energy class A.

art. A4719

dettagli • details

**piastra in policarbonato** • polycarbonate plate  
**cavo trasparente** • transparent cable  
**pulsantiera a pedale** • foot switch  
**spina europea bipolare** • european bipolar plug  
**lunghezza cavo** • wire length: **cm 370**

luce • light  
1 x 11,5 W



## kit luce in PC RGB E27 per **esterni** outdoor PC RGB E27 light kit



Il kit luce è compatibile con lampadine di classi energetiche E → A++, ed è venduto con una lampada di classe energetica A.

The light kit is compatible with bulbs of the energy class E → A++, and is sold with a bulb of the energy class A.

art. A4720

dettagli • details

**piastra in policarbonato** • polycarbonate plate  
**guscio in policarbonato** • polycarbonate shell  
**guarnizione a tenuta** • gasket seal  
**cavo nero** • black cable  
**spina schuko antispruzzo** • anti-splash  
**lunghezza cavo** • wire length: **cm 280**

luce • light  
1 x 11,5 W



## kit luce in PC RGB E27 con telecomando per **interni** indoor PC RGB E27 light kit with remote control



Il kit luce è compatibile con lampadine di classi energetiche E → A++, ed è venduto con una lampada di classe energetica A.

The light kit is compatible with bulbs of the energy class E → A++, and is sold with a bulb of the energy class A.

art. A4710

dettagli • details

**piastra in policarbonato** • polycarbonate plate  
**telecomando** • remote control  
**cavo trasparente** • transparent cable  
**pulsantiera a pedale** • foot switch  
**spina europea bipolare** • european bipolar plug  
**lunghezza cavo** • wire length: **cm 370**

luce • light  
1 x 11,5 W



## kit luce in PC RGB E27 con telecomando per **esterni** outdoor PC RGB E27 light kit with remote control



Il kit luce è compatibile con lampadine di classi energetiche E → A++, ed è venduto con una lampada di classe energetica A.

The light kit is compatible with bulbs of the energy class E → A++, and is sold with a bulb of the energy class A.

art. A4711

dettagli • details

**piastra in policarbonato** • polycarbonate plate  
**guscio in policarbonato** • polycarbonate shell  
**telecomando** • remote control  
**guarnizione a tenuta** • gasket seal  
**cavo nero** • black cable  
**spina schuko antispruzzo** • anti-splash  
**lunghezza cavo** • wire length: **cm 280**

luce • light  
1 x 11,5 W



## kit led rgb a batteria con spina per **interni/esterni**

rgb led light kit with battery with plug **indoor/outdoor**

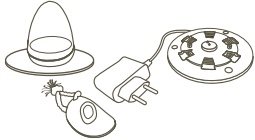

art. A4364

dettagli • details

kit led rgb powered by smart&green

autonomia 6 ore circa alla massima intensità  
autonomy 6 hours on average at maximum power

telecomando • remote control

base di ricarica con spina europea bipolare

european bipolar plug charger

diffusore in polietilene resistente ai raggi u.v. e agli urti

polyethylene plastic diffuser, resistant to u.v. and shocks

batteria li-ion polimeri 3,7V 2200 mAh

battery li-ion 3,7V 2200 mAh

luce • light

35 led: 20 led bianchi e 15 led colorati - 1,2 W

35 leds: 20 white leds and 15 color leds - 1,2 W



IP 68



## kit mini led light per **interni** mini led light kit **indoor**

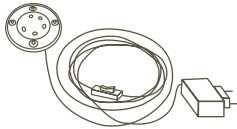

Il kit luce è munito di lampade a LED integrate con classe energetica A → A++.

The light kit is equipped with integrated LED bulbs of the energy class A → A++.

art. A4303

dettagli • details

cavo trasparente • transparent cable

spina europea bipolare • european bipolar plug

trasformatore in 12V a parete • 12V wall transformer

pulsantiera • switch

lunghezza cavo • wire length: cm 140

luce • light

modulo 6 led bianchi 1,5 W

1,5 W white 6 led module



IP 20



## kit luce a sospensione per **interni/esterni** **indoor/outdoor** light kit to suspension



Il kit luce è compatibile con lampadine di classi energetiche E → A++, ed è venduto con una lampada di classe energetica A.

The light kit is compatible with bulbs of the energy class E → A++, and is sold with a bulb of the energy class A.

art. A4596

dettagli • details

piastra in policarbonato • polycarbonate plate

guscio in policarbonato • polycarbonate shell

guarnizione a tenuta • gasket seal

cavo nero • black cable

lunghezza cavo • wire length: cm 200

fili in acciaio per la sospensine • steel wires for suspension

staffa metallica di fissaggio a soffitto • metal bracket for ceiling mount

rosone metallico • metal ceiling rose

kit luce regolabile in altezza • light kit adjustable in height

luce • light

1 x 20 W



CL. I



IP 44



# Legenda/Legend



Lampadina a LED MAX 1 x 11,5 W  
LED bulb MAX 1 x 11,5 W



Lampada fluorescente MAX 1 x 60 W  
Fluorescent lamp MAX 1 x 60 W

## CL. I

**Classe di isolamento: Classe I.**  
**Apparecchio protetto alla scossa elettrica tramite isolamento principale e provvisto di un dispositivo per la messa a terra.**  
Protection class: Class I  
Apparatus protected against electric shock through main insulation, and provided with grounding device.



**Classe di isolamento: Classe II.**  
**Con doppio isolamento e/o rinforzo in ogni parte e senza dispositivi per la messa a terra.**  
Insulation class: Class II.  
With double insulation and/or reinforcement in each part and without ground devices.



**Classe di isolamento: Classe III**  
**Con isolamento ridotto perchè destinato a essere esclusivamente alimentato da un sistema a bassissima tensione di sicurezza (minore o uguale a 48V dc) e nel quale si generano tensioni di valore superiore a quello di tale sistema.**  
Insulation class: Class III.  
With reduced insulation because the device is destined to be powered exclusively by a safety extra-low voltage system (max. 48V DC or less) in which voltages of values higher than those of such system are generated.



**Attesta la conformità del prodotto alle disposizioni delle direttive comunitarie.**  
It certifies the conformity of the product to the European community instructions.

IP 20

**Prodotto di uso ordinario. Protetto contro corpi solidi di diametro superiore a 12,5mm. L'utente non ha comunque modo di entrare in contatto con le parti in tensione. Prodotto con nessuna protezione nei confronti della penetrazione dell'acqua.**  
Product for ordinary use, protected against solid objects larger than 12.5 mm in diameter. Users cannot however come into contact with the live parts. This product has no water protection.

IP 44

**Protetto contro corpi solidi di diametro superiore ad 1 mm. Prodotto resistente agli spruzzi d'acqua.**  
Protected against solid bodies with a diameter over 1 mm. Splash-resistant product.

IP 67

**Totamente protetto contro la penetrazione di polveri. Prodotto resistente all'immersione temporanea massimo ad 1m di profondità. L'icona, dove presente, fa riferimento al corpo lampada.**  
Totally protected against penetration of dust. Product resistant against temporary immersion in water to a maximum of 1 m depth. Wherever present, the icon refers to the lamp's casing.

IP 68

**Totamente protetto contro la penetrazione di polveri. Prodotto resistente alla sommersione permanente in acqua. L'icona, dove presente, fa riferimento al corpo lampada.**  
Totally protected against penetration of dust. Product resistant against permanent immersion in water. Wherever present, the icon refers to the lamp's casing.



**Ai sensi della Direttiva 2012/19/UE, il prodotto, alla fine della sua vita utile, non deve essere smaltito come rifiuto urbano.**  
According to the Directive 2012/19/UE, once the device life time is ended, it must not be disposed as urban waste.

**Tutte le apparecchiature elettriche sono conformi alle direttive 2011/65/UE sulle Restrizioni d'uso di alcune sostanze pericolose (RoHS), recepite in Italia con il D.lgs 04/03/2014 n.27.**

All electric equipments meet the Directives 2011/65/UE about the Reduction of the use of certain Hazardous Substances (RoHS), which came into force in Italy with D. lgs 04/03/2014 n.27.

### Avvertenze - Warning:

- Tutte le lampade presenti in questo catalogo dispongono di un kit luce già installato.
- In caso di sostituzione della lampadina, assicurarsi che la presa di corrente sia scollegata.
- Collegare la spina dell'apparecchio in una presa collocata in un luogo protetto dalla pioggia e dagli spruzzi d'acqua.
- L'articolo "Sfera a sospensione" che monta il kit a sospensione (A4596), se utilizzato all'esterno, dovrà essere posizionato in luogo coperto.
- Se il cavo flessibile esterno di questo apparecchio viene danneggiato, deve essere sostituito esclusivamente dal costruttore, dal suo servizio di assistenza, o da personale qualificato equivalente, al fine di evitare pericoli.
- Nelle versioni sprovviste di interruttore sul cavo di alimentazione, collegare la spina dell'apparecchio sotto una presa comandata da interruttore.
- Si sconsiglia l'utilizzo e/o l'installazione dei prodotti luminosi su superfici/pavimentazioni non solide (sabbia, terra, erba, sassi, ghiaia, ecc.). Inoltre, i prodotti luminosi non dovranno essere installati in prossimità (adiacenti e sullo stesso piano) di piscine e/o ambienti d'acqua.
- Gli oggetti luminosi, se allestiti con terra, piante e/o vasi, dovranno essere fissati al suolo con i nostri sistemi di ancoraggio, ove previsti.
- I vasi light outdoor sono dotati di fori di drenaggio all'interno e sul fondo del vaso, oppure di canaletta di scolo. Entrambe le soluzioni servono per favorire la fuoriuscita dell'acqua in eccesso.
- La serie DUO in versione light non può essere allestita con terra, piante, vasi o con oggetti vari.
- La serie IKON in versione light non può essere allestita con terra, piante, vasi o con oggetti vari.
- Euro3Plast S.p.A. declina ogni responsabilità per danni causati a cose o a persone da un uso improprio del prodotto.

- All the lamps included in this catalogue are supplied with a light kit already installed.
- Before replacing a bulb make sure that the power plug has been disconnected.
- Connect the plug of the appliance to a power outlet that is located in a sheltered position, protected from rain and water splashes.
- If used outdoors, the article "Suspended light sphere" that mounts the suspension kit (A4596) must be installed in a covered context.
- If the external flexible cable of this appliance is damaged it must be replaced by either the manufacturer, the manufacturer's customer assistance service or by equivalent qualified personnel, in order to prevent possible hazards.
- For models that are not equipped with an inline on/off switch, connect the plug of the appliance to a switch controlled outlet.
- The use and/or installation of illumination devices on instable surfaces/floors or pavement (sand, soil, grass, stones, gravel, etc.) is discouraged.
- Neither must illumination devices be installed near (adjacent to or on the same level as) swimming pools and/or other water environments.
- If light articles are set up with earth, plants and/or vases, they must be secured to the ground with our anchoring systems, where provided.
- The light outdoor pots have drainage holes inside and on the base, or a drainage tube. Both solutions are to allow excess water to drain away.
- The light version of the DUO series cannot be set up with soil, plants, vases or various other objects.
- The light version of the IKON series cannot be set up with soil, plants, vases or various other objects.
- Euro3Plast S.p.A. cannot accept liability for any damage caused to things or persons by an incorrect use of the product.



## indice generale general index

art.	pag.
<b>a:</b>	
<b>air</b> (s/vaso trasparente • transparent saucer)	p. 85
<b>akan</b> (cassetta • plant box)	p. 242
<b>akan</b> (vaso quadro • square pot)	p. 243
<b>akea</b> (cassetta • plant box)	p. 48
<b>akea</b> (s/cassetta • oblong tray)	p. 49
<b>akuar</b> (portaombrelli • umbrella-stand)	p. 303
<b>angeli</b> (s/vaso • saucer)	p. 283
<b>angeli</b> (vaso • pot)	p. 283
<b>ariete</b> (fioriera • vase)	p. 290
<b>azem</b> (ciotola appesa • hanging plant bowl)	p. 78
<b>azem</b> (fioriera • vase)	p. 79
<b>b:</b>	
<b>balaustra</b> (balustrade)	p. 301
<b>balaustra per fiori</b> (balustrade for flowers)	p. 301
<b>balaustra festonata</b> (cassetta • plant box)	p. 278
<b>balaustra festonata</b> (s/cassetta • oblong tray)	p. 275
<b>balaustra liscia</b> (cassetta • plant box)	p. 275
<b>basamento</b> (base)	p. 303
<b>be up</b> (cassetta • plant box)	p. 110
<b>be up</b> (vaso con riserva • pot with water reserve)	p. 108
<b>c:</b>	
<b>camelie liscio</b> (s/vaso • saucer)	p. 284
<b>camelie liscio</b> (vaso • pot)	p. 284
<b>cesare augusto</b> (busto • bust)	p. 297
<b>cilindro</b> (s/vaso • saucer)	p. 262
<b>cilindro</b> (vaso • pot)	p. 38
<b>cilindro rot</b> (vaso • pot)	p. 262
<b>clivo</b> (cassetta • plant box)	p. 138
<b>clivo</b> (vaso • pot)	p. 134
<b>clivo</b> (vaso con fori • pot with holes)	p. 132
<b>clivo orchidea</b> (vaso • pot)	p. 136
<b>coccio</b> (vaso • pot)	p. 40
<b>conchiglia</b> (fontana • fountain)	p. 302
<b>creta</b> (colonna • column)	p. 298
<b>cubik</b> (vaso • pot)	p. 150
<b>cubik vision</b> (vaso neutro trasparente • transparent pot)	p. 152
<b>d:</b>	
<b>decorata</b> (conca • conch)	p. 281
<b>decorata</b> (s/vaso conca • conch saucer)	p. 281
<b>dekus air</b> (s/vaso quadro trasparente • square transparent saucer)	p. 85
<b>domus</b> (gerla con s/vaso • wall pot with saucer)	p. 79
<b>donna francese</b> (busto • bust)	p. 296
<b>duo</b> (vaso con container • pot with container)	p. 96
<b>duo</b> (vaso quadro con container • square pot with container)	p. 100
<b>duo</b> (con container light • with container light)	p. 98
<b>duo</b> (quadro con container light • square with container light)	p. 102
<b>doppio bordo</b> (s/vaso • saucer)	p. 257

---

art. pag.

---

**d:**

**doppio bordo** (vaso • pot) p. 256  
**dune** (cassetta con s/cassetta montata • plant box with oblong tray) p. 64  
**dune** (vaso • pot) p. 42

**e:**

**eden** (ciotola • plant bowl) p. 270  
**olia** (ciotola appesa con s/vaso montato • hanging plant bowl with attached saucer) p. 78  
**olia** (ciotola con s/vaso montato • plant bowl with attached saucer) p. 78  
**etria** (vaso con doppia parete • pot with double wall) p. 214  
**etria uno** (vaso con singola parete • pot with single wall) p. 215  
**etrus** (vaso • pot) p. 284  
**etrusca** (fioriera • vase) p. 291  
**eur** (s/vaso • saucer) p. 258

**f:**

**festonato** (vaso • pot) p. 258  
**festonato special colors** (vaso • pot) p. 259  
**festone** (s/cassetta • oblong tray) p. 287  
**festone** (cassetta • plant box) p. 276  
**festum** (vaso • pot) p. 260  
**flor** (cassetta • plant box) p. 278  
**foglie** (cassetta • plant box) p. 279  
**foglie** (s/cassetta • oblong tray) p. 279  
**foglie** (vaso quadro • square pot) p. 279

**g:**

**garden** (s/cassetta • oblong tray) p. 59  
**garden** (vaso • pot) p. 46  
**gardenie** (cassetta • plant box) p. 56  
**gardenie** (s/cassetta • oblong tray) p. 57  
**geo** (vaso • pot) p. 34  
**gerani** (cassetta • plant box) p. 58  
**gerani** (s/cassetta • oblong tray) p. 58  
**giottus** (ciotola • plant bowl) p. 271  
**guya** (vaso • pot) p. 36

**h:**

**hermes** (fioriera ovale • oval vase) p. 291

**i:**

**idria** (s/vaso • saucer) p. 285  
**ikon** (s/vaso • saucer) p. 199  
**ikon** (vaso • pot) p. 198  
**ikon** (vaso con fori • pot with holes) p. 200  
**ikon** (vaso con fori chiuso sopra • pot with holes closed on top) p. 201  
**ikon laccato** (vaso laccato • lacquered pot) p. 202  
**ikon** (vaso light • light pot) p. 204  
**ikon mini** (vaso • pot) p. 208  
**ikon mini** (vaso light • light pot) p. 210

## indice generale general index

art.	pag.
<b>i:</b>	
ilie (vaso • pot)	p. 216
ilie gloss (vaso • pot)	p. 218
ilie (vaso light • light pot)	p. 220
impero (fioriera • vase)	p. 291
inis (cassetta • plant box)	p. 54
inis (s/cassetta • oblong tray)	p. 55
<b>k:</b>	
kalis (cassetta • plant box)	p. 60
kalis (cassetta con riserva acqua • plant box with water reserve)	p. 62
kalis (s/cassetta • oblong tray)	p. 61
kezar (cassetta con s/cassetta montata • plant box with attached oblong tray)	p. 70
kiam (vaso quadro • square pot)	p. 222
kiam gloss (vaso quadro • square pot)	p. 224
kiam (vaso quadro light • square light pot)	p. 226
kos (colonna • column)	p. 299
krea (s/vaso a muro • wall saucer)	p. 53
krea (s/vaso angolo • angle saucer)	p. 52
krea (s/vaso quadro • square saucer)	p. 51
krea (vaso a muro • wall pot)	p. 53
krea (vaso angolo • angle pot)	p. 52
krea (vaso quadro • square pot)	p. 50
kube (cassetta • plant box)	p. 162
kube (cassetta con ruote • plant box with castors)	p. 162
kube (panca • bench)	p. 190
kube special colors (panca • bench)	p. 192
kube (panca light • light bench)	p. 194
kube (sgabello • stool)	p. 191
kube special colors (sgabello • stool)	p. 193
kube (sgabello light • light stool)	p. 195
kube (vaso • pot)	p. 163
kube (vaso con ruote • pot with castors)	p. 163
kube gloss (vaso • pot)	p. 164
kube gloss (vaso con ruote • pot with castors)	p. 165
kube high (cassetta alta • high plant box)	p. 172
kube high (cassetta alta con ruote • high plant box with castors)	p. 172
kube high special colors (cassetta alta • high plant box)	p. 174
kube high (cassetta alta light • high light plant box)	p. 176
kube high (vaso alto • high pot)	p. 173
kube high (vaso alto con ruote • high pot with castors)	p. 173
kube high special colors (vaso alto • high pot)	p. 175
kube high (vaso alto light • high light pot)	p. 177
kube high slim (cassetta alta • high plant box)	p. 178
kube high slim (cassetta alta light • high light plant box)	p. 180
kube high slim (modulo • module)	p. 182
kube high slim (vaso alto • high pot)	p. 179
kube high slim (vaso alto light • high light pot)	p. 181
kube mini (cassetta • plant box)	p. 166
kube mini (cassetta con riserva • plant box with water reserve)	p. 168
kube mini (cassetta light • light plant box)	p. 170
kube mini (cubo light • light cube)	p. 196

---

art.

pag.

---

**k:**

<b>kube mini</b> (vaso • pot)	p. 167
<b>kube mini</b> (vaso con riserva • pot with water reserve)	p. 169
<b>kube mini</b> (vaso light • light pot)	p. 171
<b>kube tower</b> (cassetta alta • high plant box)	p. 184
<b>kube tower special colors</b> (cassetta alta • high plant box)	p. 186
<b>kube tower</b> (cassetta alta light • high light plant box)	p. 188
<b>kube tower</b> (vaso alto • high pot)	p. 185
<b>kube tower special colors</b> (vaso alto • high pot)	p. 187
<b>kube tower</b> (vaso alto light • high light pot)	p. 189
<b>kubis</b> (vaso quadro • square pot)	p. 275
<b>kuno gloss</b> (vaso • pot)	p. 228

---

**l:**

<b>leone</b> (piedino • little base)	p. 287
<b>leone</b> (statua • statue)	p. 295
<b>libis</b> (ciotola con s/vaso montato • plant bowl with attached saucer)	p. 76
<b>licum</b> (cassetta con s/cass. mont. • plant box with oblong tray)	p. 66
<b>lik</b> (vaso • pot)	p. 272
<b>liken</b> (vaso • pot)	p. 140
<b>lindos</b> (colonna • column)	p. 299
<b>linto</b> (vaso • pot)	p. 44

---

**m:**

<b>maxi</b> (s/cassetta • oblong tray)	p. 87
<b>medea</b> (s/vaso • saucer)	p. 80
<b>mey</b> (copri vaso • plant pot holder)	p. 144
<b>mey</b> (copri vaso con ruote • plant pot holder whit rolles)	p. 145
<b>millerighe</b> (cassetta • plant box)	p. 264
<b>millerighe special colors</b> (cassetta • plant box)	p. 266
<b>millerighe</b> (s/cassetta • oblong tray)	p. 286
<b>millerighe</b> (vaso a muro • wall pot)	p. 255
<b>millerighe</b> (vaso angolo • angle pot)	p. 255
<b>millerighe</b> (vaso quadro • square pot)	p. 265
<b>millerighe special colors</b> (vaso quadro • square pot)	p. 267
<b>mini</b> (s/cassetta • oblong tray)	p. 86
<b>mitu</b> (ciotola • plant bowl)	p. 130
<b>mitu</b> (ciotola con fori • plant bowl with holes)	p. 128
<b>mitu</b> (vaso • pot)	p. 124
<b>mitu vision</b> (vaso neutro trasparente • transparent pot)	p. 126
<b>mitu</b> (s/vaso • saucer)	p. 129
<b>mitu pac cm 100</b> (cassetta con fori • plant box with holes)	p. 112
<b>mitu pac</b> (cassetta con fori • plant box with holes)	p. 116
<b>mitu pac</b> (cassetta con riserva • plant box with water reserve)	p. 118
<b>mitu pac</b> (vaso con fori • pot with holes)	p. 120
<b>mitu pac quadro</b> (vaso con fori quadro • square pot with holes)	p. 114
<b>mitu tre</b> (ciotola • plant bowl)	p. 158
<b>miu</b> (vaso • pot)	p. 142
<b>miza</b> (cassetta • plant box)	p. 68
<b>miza</b> (s/cassetta • oblong tray)	p. 69
<b>moplen</b> (s/cassetta • oblong tray)	p. 87
<b>moplen</b> (s/vaso • saucer)	p. 84

## indice generale

### general index

art.	pag.
<b>n:</b>	
<b>nettuno</b> (fontana • fountain)	p. 302
<b>neze</b> (s/vaso quadro • square saucer)	p. 286
<b>niscal</b> (vaso • pot)	p. 240
<b>o:</b>	
<b>oasi &amp; pashà</b> (tavolino & poltroncina • small table & small armchair)	p. 292
<b>olimpo</b> (ciotola • plant bowl)	p. 74
<b>olimpo</b> (gerla con s/vaso • wall pot with saucer)	p. 79
<b>opus</b> (vaso • pot)	p. 238
<b>orcio</b> (orcio • pitcher)	p. 288
<b>orcio impluvium</b> (orcio • pitcher)	p. 289
<b>ornato</b> (s/vaso • saucer)	p. 282
<b>ornato</b> (vaso • pot)	p. 282
<b>p:</b>	
<b>pamir</b> (basamento • base)	p. 302
<b>pamir grande</b> (basamento • base)	p. 294
<b>panchina semitonda</b> (halfround bench)	p. 300
<b>paracarro con catena</b> (post with chain)	p. 300
<b>pashà &amp; oasi</b> (poltroncina & tavolino • small armchair & small table)	p. 292
<b>piedino</b> (piedino • little base)	p. 59
<b>piedistallo per statua</b> (pedestal for statue)	p. 294
<b>pilastro per balaustra</b> (balustrade pilaster)	p. 300
<b>plant</b> (cassetta per legna con ruote • firewood log holder with wheels)	p. 305
<b>pompei</b> (capitello quadro • square capital)	p. 298
<b>pompei</b> (colonna • column)	p. 298
<b>putti</b> (fioriera • vase)	p. 290
<b>putto toscano</b> (statua • statue)	p. 295
<b>q:</b>	
<b>quadria</b> (vaso • pot)	p. 148
<b>quadro</b> (s/vaso quadro • square saucer)	p. 86
<b>quadrum</b> (vaso quadro • square pot)	p. 230
<b>quadrum laccato</b> (vaso laccato quadro • lacquered square pot)	p. 232
<b>quadrum</b> (vaso quadro light • square light pot)	p. 234
<b>quattro stagioni</b> (basamento • base)	p. 296
<b>quattro stagioni</b> (statua autunno • autumn statue)	p. 296
<b>quattro stagioni</b> (statua estate • summer statue)	p. 296
<b>quattro stagioni</b> (statua inverno • winter statue)	p. 296
<b>quattro stagioni</b> (statua primavera • spring statue)	p. 296
<b>r:</b>	
<b>rigata</b> (cassetta • plant box)	p. 72
<b>rodi</b> (capitello • capital)	p. 298
<b>rodi</b> (colonna • column)	p. 298
<b>rondò</b> (s/vaso con ruote • saucer with wheels)	p. 285

---

art.

pag.

---

**S:**

<b>sabbiato</b> (s/vaso • saucer)	p. 84
<b>sasso</b> (stone)	p. 303
<b>sfera</b> (light sphere)	p. 244
<b>sfera a sospensione</b> (suspended light sphere)	p. 245
<b>sfera con piedistallo</b> (light sphere with pedestal)	p. 246
<b>sfera mini</b> (mini light sphere)	p. 248
<b>siepi</b> (cassetta • plant box)	p. 250
<b>siepi</b> (cassetta con doppia parete • plant box with double wall)	p. 252
<b>siepi</b> (s/cassetta • oblong tray)	p. 252
<b>siepi</b> (vaso • pot)	p. 254
<b>siepi</b> (vaso a muro • wall pot)	p. 254
<b>siepi</b> (vaso angolo • angle pot)	p. 254
<b>siepi</b> (vaso quadro • square pot)	p. 251
<b>siepi</b> (vaso quadro con doppia parete • square pot with double wall)	p. 253
<b>simple rot</b> (vaso • pot)	p. 212
<b>sottovaso angolo</b> (angle saucer)	p. 254
<b>sottovaso a muro</b> (wall saucer)	p. 254
<b>steccato con base</b> (fence with base)	p. 304
<b>synue</b> (vaso • pot)	p. 146
<b>s/vaso con ruote</b> (s/vaso con ruote montate • saucer with attached wheels)	p. 82

**t:**

---

<b>tempium</b> (s/vaso • saucer)	p. 263
<b>tempium</b> (vaso • pot)	p. 263
<b>tere</b> (cassetta • plant box)	p. 268
<b>tere</b> (vaso quadro • square pot)	p. 269
<b>thera</b> (basamento • base)	p. 294
<b>toscana</b> (cassetta con doppia parete • plant box with double wall)	p. 274
<b>toscana</b> (vaso quadro con doppia parete • square pot with double wall)	p. 274
<b>trio</b> (espositore per vasi e cassette • pot and plant box display)	p. 304
<b>truk</b> (carrello con timone • wagon with handle)	p. 304
<b>tuit</b> (vaso con container • pot with container)	p. 90
<b>tuit krome</b> (vaso con container • pot with container)	p. 94
<b>tuit laccato opaco</b> (vaso laccato opaco con container • pot matt lacquered with container)	p. 92
<b>tuliki</b> (cassetta • plant box)	p. 278
<b>tuliki</b> (vaso quadro • square pot)	p. 278
<b>tulum</b> (vaso • pot)	p. 236
<b>tum</b> (vaso quadro • square pot)	p. 273
<b>turfan</b> (fioriera • vase)	p. 290
<b>twister</b> (ciotola • plant bowl)	p. 154

**U:**

---

<b>ulivum</b> (conca • conch)	p. 280
<b>ulivum</b> (s/vaso conca • conch saucer)	p. 280
<b>up</b> (cassetta • plant box)	p. 106
<b>up</b> (vaso con riserva • pot with water reserve)	p. 104

## indice generale general index

art.	pag.
<b>V:</b>	
<b>venere</b> (busto • bust)	p. 297
<b>venere</b> (statua • statue)	p. 294
<b>venere mini</b> (statua • statue)	p. 294
<b>venere piccola</b> (statua • small statue)	p. 294
<b>venere milo</b> (statua • statue)	p. 294
<b>venere milo mini</b> (statua • statue)	p. 294
<b>venere milo piccola</b> (statua • small statue)	p. 294
<b>vertigo</b> (vaso • pot)	p. 156
<b>Z:</b>	
<b>zetis</b> (colonna • column)	p. 299

—



ATTENZIONE: La stampa su carta non sempre riproduce fedelmente i colori dei prodotti.

Le immagini e i dati riportati in questo catalogo sono indicativi. **Euro3plast spa** si riserva il diritto di apportare eventuali variazioni o migliorie agli articoli illustrati, anche senza preavviso. I nostri uffici commerciali rimangono a vostra completa disposizione per qualsiasi ulteriore delucidazione.

Tutto il materiale contenuto in questo catalogo, compresi i testi, le fotografie, i disegni, è proprietà di **euro3plast spa** e pertanto è protetto dalle leggi che tutelano la proprietà intellettuale. Per tale motivo non può essere utilizzato senza esplicita autorizzazione scritta da **euro3plast spa**.

ATTENTION: The print on the paper doesn't grant the accurate reproduction of the colors.

The images and the indicated data in our catalogue are approximate. **Euro3plast spa** reserves the right to effect any changes or improvements, to the illustrated articles, also without notice. For further information, our Customer Service are at your disposal.

All the material in this catalogue (including texts, photos and drawing), belong to **euro3plast spa**. Therefore it is protected by laws defending intellectual property. For this reason it cannot be used by anybody without the prior and written authorization of **euro3plast spa**.

# hobby & home colors

# style colors

## finishings



opaco  
matt



lucido  
gloss



special  
colors



light

## product information



dimensioni esterne  
external dimensions



capacità terra  
soil capacity



capacità terra del container  
container soil capacity



capacità riserva acqua  
water reserve capacity



porta cassetta  
bracket



imballo minimo  
minimum pack

## good for plants



pp



pc



abs



lhdpe



vaso con fori  
pot with holes

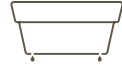

cassetta con fori  
plant box with holes



sottovaso abbinato  
fitting saucer



sottocassetta abbinata  
fitting oblong tray



sottovaso montato  
attached saucer



sottocassetta montata  
attached oblong tray



coprivaso  
cachepot



kit riserva d'acqua  
water reserve kit

## easy for sales



rifinito a mano  
hand-finished



impilabile  
stackable



vaso abbinato  
matching pot



cassetta abbinata  
matching plant box



kit fissaggio a terra  
ground fixing kit



kit posacenere  
ashtray kit



kit luce montato  
installed light kit

## display solutions



espositore  
display

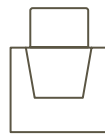

palbox



coverpallet



8 000072 142136

printed in italy 09/2019

**euro3plast spa**

viale del lavoro, 45  
36048 ponte di barbarano (vi) • italy

t +39 0444 788200  
f +39 0444 788290

[www.euro3plast.com](http://www.euro3plast.com)  
[info@euro3plast.com](mailto:info@euro3plast.com)